

BS 5228-1:2009+A1:2014



BSI Standards Publication

Code of practice for noise and vibration control on construction and open sites – Part 1: Noise

bsi.

...making excellence a habit.™

Publishing and copyright information

The BSI copyright notice displayed in this document indicates when the document was last issued.

© The British Standards Institution 2014
Published by BSI Standards Limited 2014

ISBN 978 0 580 77749 3

ICS 17.140.20; 91.200

The following BSI references relate to the work on this standard:
Committee reference B/564/1
Drafts for comment 08/30141420 DC, 13/30258085 DC

Publication history

First published as BS 5228, May 1975
First published as BS 5228-1, BS 5228-2 and BS 5228-3, May 1984
Second edition of BS 5228-1, BS 5228-2 and BS 5228-3, May 1997
First edition of BS 5228-4, January 1986
Second edition of BS 5228-4, May 1992
First edition of BS 5228-5, November 1997
Present (third) edition in two parts, December 2008

Amendments issued since publication

Date	Text affected
February 2014	A1. See Foreword

Contents

Foreword *iii*

1	Scope	1
2	Normative references	1
3	Terms and definitions	1
4	Community relations	3
5	Noise and persons on site	4
5.1	Training	4
5.2	Protection from noise-induced hearing loss	4
5.3	Ear protectors	5
5.4	Noise-induced stress	5
6	Neighbourhood nuisance	6
6.1	Disturbing effects of noise	6
6.2	Environmental noise descriptor	6
6.3	Issues associated with noise effects and community reaction	6
7	Project supervision	8
7.1	General	8
7.2	Works preparation	8
7.3	Execution of works	9
7.4	Emergencies	10
8	Control of noise	10
8.1	General	10
8.2	Control of noise at source	11
8.3	Controlling the spread of noise	13
8.4	Noise control targets	15
8.5	Noise control from piling sites	15
8.6	Noise control from surface coal extraction	18
8.7	Noise control from surface mineral (except coal) extraction sites	22

Annexes

Annex A (informative)	Legislative background	25
Annex B (informative)	Noise sources, remedies and their effectiveness	35
Annex C (informative)	Current sound level data on site equipment and site activities	44
Annex D (informative)	Historic sound level data on site equipment and site activities	71
Annex E (informative)	Significance of noise effects	117
Annex F (informative)	Estimating noise from sites	123
Annex G (normative)	Noise monitoring	144
Annex H (informative)	Types of piling	147
Annex I (informative)	Air overpressure	151

Bibliography 153

List of figures

Figure A.1	– Procedures to control construction noise under the Control of Pollution Act 1974	28
Figure B.1	– Example of machine enclosure	40
Figure B.2	– Typical acoustic shed	41
Figure B.3	– Examples of acoustic open-sided sheds	42
Figure F.1	– Flow chart for the prediction of site noise	128
Figure F.2	– Distance adjustment K for activity $L_{Aeq, T}$ method	130
Figure F.3	– Screening effect of barriers	131
Figure F.4	– Distance adjustment K' for plant sound power method	134
Figure F.5	– Adjustment to sound level to give resulting $L_{Aeq, T}$ (plant sound power method)	134

- Figure F.6 – Office development site showing plant locations in relation to the nearest affected façade 139
 Figure F.7 – Spoil movement on a haul road showing location of the nearest affected property 142
 Figure H.1 – Piling and kindred ground treatment systems 148

Tables

- Table B.1 – Methods of reducing noise levels from construction plant 36
 Table B.2 – Sound insulation characteristics of common building materials 39
 Table B.3 – Sound-absorbing materials for lining covers and enclosures 40
 Table B.4 – Measured sound reduction given by types of partial enclosure 41
 Table C.1 – Sound level data on demolition 45
 Table C.2 – Sound level data on site preparation 46
 Table C.3 – Sound level data on piling and ancillary operations 48
 Table C.4 – Sound level data on general site activities 50
 Table C.5 – Sound level data on road construction works 55
 Table C.6 – Sound level data on opencast coal sites 57
 Table C.7 – Sound level data on dredging 59
 Table C.8 – Sound level data on waste disposal sites 59
 Table C.9 – Sound level data on hard rock quarries 61
 Table C.10 – Sound level data on other quarries (i.e. sand and gravel) 62
 Table C.11 – General sound level data 64
 Table C.12 – Supplementary sound level data on piling 65
 Table D.1 – Index of site equipment referred to in Tables D.2 to D.12 72
 Table D.2 – Historic sound level data on demolition 77
 Table D.3 – Historic sound level data on site preparation 78
 Table D.4 – Historic sound level data on piling: piling operations 83
 Table D.5 – Historic sound level data on piling: ancillary operations 94
 Table D.6 – Historic sound level data on concreting operations 94
 Table D.7 – Historic sound level data on general site activities 97
 Table D.8 – Historic sound level data on roadworks 102
 Table D.9 – Historic sound level data on motorway construction 104
 Table D.10 – Historic sound level data on opencast coal sites: pre 1984 106
 Table D.11 – Historic sound level data on opencast coal sites: post 1990 114
 Table D.12 – Historic sound level data on dredging 116
 Table E.1 – Example threshold of potential significant effect at dwellings 119
 Table E.2 – Examples of time periods, averaging times and noise levels associated with the determination of eligibility for noise insulation 121
 Table F.1 – EC noise limits for certain items of construction equipment 125
 Table F.2 – Relationship of distance ratio and on-time correction factor for slow moving plant 127
 Table F.3 – Addition of steady sound levels 137
 Table F.4 – Example of prediction of noise from stationary plant 140
 Table F.5 – Example of prediction of noise from mobile plant 140
 Table G.1 – Estimation of daily $L_{Aeq,T}$ according to sampling technique 146

Summary of pages

This document comprises a front cover, an inside front cover, pages i to iv, pages 1 to 158, an inside back cover and a back cover.

Foreword

Publishing information

This part of BS 5228 is published by BSI Standards Limited, under licence from The British Standards Institution, and came into effect on 1 January 2009. It was prepared by Subcommittee B/564/1, *Noise control working group*, under the authority of Technical Committee B/564, *Noise control on construction and open sites*. A list of organizations represented on this committee can be obtained on request to its secretary.

Supersession

Together with BS 5228-2:2009, this part of BS 5228 supersedes BS 5228-1:1997, BS 5228-2:1997, BS 5228-3:1997, BS 5228-4:1992 and BS 5228-5:1997, which are withdrawn.

BS 5228-1:2009+A1:2014 supersedes BS 5228-1:2009, which is withdrawn.

Relationship with other publications

BS 5228 is published in two parts:

- Part 1: *Noise*;
- Part 2: *Vibration*.

BS 6164 gives guidance on occupational health issues relevant to tunnelling.

Information about this document

This British Standard refers to the need for the protection against noise and vibration of persons living and working in the vicinity of, and those working on, construction and open sites. It recommends procedures for noise and vibration control in respect of construction operations and aims to assist architects, contractors and site operatives, designers, developers, engineers, local authority environmental health officers and planners.

Noise and vibration can cause disturbance to processes and activities in neighbouring buildings, and in certain extreme circumstances vibration can cause or contribute to building damage.

Noise and vibration can be the cause of serious disturbance and inconvenience to anyone exposed to it and in certain circumstances noise and vibration can be a hazard to health. Attention is drawn to the legislation summarized in Annex A.

BS 5228-1:2009 was a full revision of this part of BS 5228, and introduced the following principal changes:

- restructuring of the standard into two parts, one dealing with noise and one with vibration;
- updating of information relating to legislative requirements;
- updating of information relating to methods and equipment.

Text introduced or altered by Amendment No.1 is indicated in the text by tags $\boxed{A1}$ $\langle A1 \rangle$. Minor editorial changes are not tagged.

NOTE Copyright is claimed in Tables C.1 to C.11. The copyright holder is the Department for Environment, Food and Rural Affairs (Defra), Nobel House, 17 Smith Square, London SW1P 3JR.

Use of this document

As a code of practice, this part of BS 5228 takes the form of guidance and recommendations. It should not be quoted as if it were a specification and particular care should be taken to ensure that claims of compliance are not misleading.

Any user claiming compliance with this part of BS 5228 is expected to be able to justify any course of action that deviates from its recommendations.

Presentational conventions

The provisions in this standard are presented in roman (i.e. upright) type. Its recommendations are expressed in sentences in which the principal auxiliary verb is “should”.

Commentary, explanation and general informative material is presented in smaller italic type, and does not constitute a normative element.

Contractual and legal considerations

This publication does not purport to include all the necessary provisions of a contract. Users are responsible for its correct application.

Compliance with a British Standard cannot confer immunity from legal obligations.

1 Scope

This part of BS 5228 gives recommendations for basic methods of noise control A_1 relating to construction sites, including sites where demolition, remediation, ground treatment or related civil engineering works are being carried out, and open sites, A_1 where work activities/operations generate significant noise levels, including industry-specific guidance.

The legislative background to noise control is described and recommendations are given regarding procedures for the establishment of effective liaison between developers, site operators and local authorities.

This part of BS 5228 provides guidance concerning methods of predicting and measuring noise and assessing its impact on those exposed to it.

2 Normative references

The following referenced documents are indispensable for the application of this document. For dated references, only the edition cited applies. For undated references, the latest edition of the referenced document (including any amendments) applies.

BS 4727-3:Group 08, *Glossary of electrotechnical, power, telecommunication, electronics, lighting and colour terms – Part 3: Terms particular to telecommunications and electronics – Group 08: Acoustics and electroacoustics*

BS 7580-1:1997, *Specification for the verification of sound level meters – Part 1: Comprehensive procedure*

BS 7580-2:1997, *Specification for the verification of sound level meters – Part 2: Shortened procedure for type 2 sound level meters*

A_1 BS EN 60942:2003, *Electroacoustics – Sound calibrators*

BS EN 61672-1:2013, *Electroacoustics – Sound level meters – Part 1: Specifications*

BS EN 61672-3:2013, *Electroacoustics – Sound level meters – Part 3: Periodic tests* A_1

3 Terms and definitions

For the purposes of this part of BS 5228, the definitions given in BS 4727-3:Group 08 and the following apply.

NOTE Where applicable, the definitions are consistent with those given in BS 7445-1, BS 7445-2 and BS 7445-3.

3.1 activity A_1 $L_{\text{Aeq}, T}$ A_1

NOTE The activity might involve the operation of more than one item of plant.

value of the equivalent continuous A-weighted sound pressure level determined at a distance of 10 m from, and over the period of, a given activity

3.2 air overpressure

NOTE Air overpressure can be quantified either as a pressure or as a level in linear (unweighted) decibels (dB).

airborne pressure waves generated by blasting, produced over a range of frequencies including those which are audible and those which are below the lower end of the audible spectrum

3.3 ambient noise

NOTE 1 Ambient noise is normally expressed as the equivalent continuous A-weighted sound pressure level $L_{Aeq, T}$.

NOTE The reference sound pressure is 20 μPa (2×10^{-5} Pa).

$L_{Aeq, T}$ noise in a given situation at a given time, usually composed of sound from many sources near and far, but excluding site noise

NOTE 2 Ambient noise plus site noise gives total noise.

3.4 A-weighted sound pressure level, L_{pA}

ten times the logarithm to the base 10 of the ratio of the square of the sound pressure to the square of the reference sound pressure, determined by use of frequency-weighting network "A" and time-weighting "S" or "F" (see BS EN 61672-1), expressed in decibels

3.5 background noise

A-weighted sound pressure level of the residual noise at the assessment position that is exceeded for 90% of a given time interval, T , measured using time weighting, F , and quoted to the nearest whole number in decibels

3.6 baffle mound

temporary dump usually formed from topsoil or subsoil, for the purpose of reducing noise from the site and to provide a visual screen

3.7 equivalent continuous A-weighted sound pressure level

value of the A-weighted sound pressure level of a continuous, steady sound that, within a specified time interval T , has the same mean square sound pressure as a sound under consideration whose level varies with time

NOTE The equivalent continuous A-weighted sound pressure level is calculated as follows:

$$L_{Aeq, T} = 10 \log_{10} \left[\frac{1}{T} \int_0^T \frac{p_A^2(t)}{p_0^2} dt \right]$$

where:

$L_{Aeq, T}$ is the equivalent continuous A-weighted sound pressure level, in decibels (dB), determined over a time interval T ;

$p_{A(t)}$ is the instantaneous A-weighted sound pressure, in pascals (Pa);

p_0 is the reference sound pressure (i.e. 20 μPa).

3.8 maximum sound level

NOTE The maximum sound level is represented by L_{Amax} .

highest value of the A-weighted sound pressure level with a specified time weighting that occurs during a given event

3.9 noise-sensitive premises (NSPs)

NOTE This can include national parks, areas of outstanding natural beauty or other outdoor spaces where members of the public might reasonably expect quiet enjoyment of the area.

any occupied premises outside a site used as a dwelling (including gardens), place of worship, educational establishment, hospital or similar institution, or any other property likely to be adversely affected by an increase in noise level

3.10 one percentile level

NOTE The one percentile level is represented by $L_{A01, T}$.

A-weighted sound pressure level (obtained by using the time weighting F) that is exceeded for 1% of the time interval T

3.11 open site

site where there is significant outdoor excavation, levelling or deposition of material

NOTE 1 Examples include quarries, mineral extraction sites, an opencast coal site or other site where an operator is involved in the outdoor winning or working of minerals.

NOTE 2 Waste disposal sites and long term construction projects can, in most cases, be treated as open sites.

3.12 overburden

material overlying the coal, or mineral or minerals to be extracted, including topsoil and subsoil

NOTE Economic deposits of other minerals can occur in the overburden.

3.13 piling

installation or removal of bored, driven and pressed-in piles and the effecting of ground treatments by vibratory, dynamic or other methods of ground stabilization

3.14 residual noise

ambient noise remaining at a given position in a given situation when the specific noise source is suppressed to a degree such that it does not contribute to the ambient noise

NOTE Ambient noise is normally expressed as the equivalent continuous A-weighted sound pressure level $L_{Aeq,T}$.

3.15 site noise

noise in the neighbourhood of a site that originates from the site

NOTE Ambient noise plus site noise gives total noise.

3.16 sound power level, L_{WA}

ten times the logarithm to the base 10 of the ratio of the sound power radiated by a sound source to the reference sound power, determined by use of frequency-weighting network "A" (see BS EN 61672-1), expressed in decibels

NOTE The reference sound power is 1 pW (10^{-12} W).

3.17 traverse length

length of travel of a mobile item of plant operating on a repetitive cycle

4 Community relations

Good relations with people living and working in the vicinity of site operations are of paramount importance. Early establishment and maintenance of these relations throughout the carrying out of site operations will go some way towards allaying people's fears.

It is suggested that good relations can be developed by keeping people informed of progress and by treating complaints fairly and expeditiously. The person, company or organization carrying out work on site should appoint a responsible person to liaise with the public. The formation of liaison committees with members of the public can be considered for longer term projects when relatively large numbers of people are involved.

Noise from blasting operations is a special case and can under some circumstances give rise to concern or even alarm to persons unaccustomed to it. The adoption of good blasting practices will reduce the inherent and associated impulsive noise: prior warning to members of the public, individually if necessary, is important.

NOTE The government has published research on the environmental effects of noise from blasting [1].

5 Noise and persons on site

5.1 Training

NOTE Attention is drawn to Regulation 10 of the Control of Noise at Work Regulations 2005 [2], which requires all employees to be informed about the need to minimize noise and about the health hazards of exposure to excessive noise.

Operatives should be trained to employ appropriate techniques to keep site noise to a minimum, and should be effectively supervised to ensure that best working practice in respect of noise reduction is followed. All employees should be advised regularly of the following, as part of their training:

- a) the proper use and maintenance of tools and equipment;
- b) the positioning of machinery on site to reduce the emission of noise to the neighbourhood and to site personnel;
- c) the avoidance of unnecessary noise when carrying out manual operations and when operating plant and equipment;
- d) the protection of persons against noise;
- e) the operation of sound measuring equipment (selected personnel).

Special attention should be given to the use and maintenance of sound-reduction equipment fitted to power tools and machines.

Persons issued with ear protection equipment should be instructed on its use, care and maintenance.

Education programmes should be provided which draw attention to the harmful effects of noise and make it clear that there are several ways in which employees can help themselves to protect their hearing, for example:

- by using and maintaining measures adopted for noise control;
- by reporting defective noise control equipment to their superiors;
- by not damaging or misusing ear protectors provided and by immediately reporting damage to or loss of such items to their superiors.

A programme of monitoring should be implemented to ensure that condition limits are not exceeded and that all the relevant recommendations are met.

Managers and supervisors can help by recognizing the need for employees to make proper use of equipment so that noise emission will be minimized, and to make proper use of ear protectors when required.

5.2 Protection from noise-induced hearing loss

NOTE Attention is drawn to the Control of Noise at Work Regulations 2005 [2].

Exposure to high noise levels for unprotected ears can be a serious hazard to health, causing permanent damage to hearing. The use of plant and/or power tools on site can create areas of potential noise hazard. The risk can be reduced by limiting the exposure (i.e. the combination of the quantity of noise and the duration of exposure).

Noise exposure can be increased to a hazardous level by reverberation from reflecting surfaces and special care should be exercised when using equipment in confined spaces, e.g. in basements and between reflecting walls. Steps should be taken to reduce noise levels when

several items of equipment, that might be relatively quiet when in use singly, are to be used simultaneously, to avoid hazard to the users and to persons working in the vicinity.

If persons that are on site but not engaged in noisy operations cannot be given quiet areas in which to work and noise from machines cannot be properly silenced, then noise screens should, whenever possible, be erected having due regard for safety considerations. (See also Annex B.) Certain operations, e.g. mechanical crushing, might necessitate the use of purpose-made acoustic cabins to afford proper protection to the operators.

Screens and barriers themselves reflect noise which can be reduced by covering their inner surfaces with noise-absorbent material to protect persons required to work on the noisy side. (See also Annex B.)

Plant from which the noise generated is known to be particularly directional should, wherever practicable, be orientated so that attendant operators of the plant can benefit from this acoustical phenomenon by sheltering, when possible, in the area with reduced noise levels.

Account should always be taken of the need to minimize noise and to protect quiet areas from its impact when the layout of plant and the phasing of operations are being considered. (See also Annex C and Annex D.)

Tools should be sound-reduced and the operator should be supplied with the appropriate hearing protection (see 5.3).

Noise in the cabs of machines can be reduced by damping of the cab walls, provision of a sound-absorbing lining and a well-sealed floor cover, as appropriate.

5.3 Ear protectors

NOTE Attention is drawn to the Control of Noise at Work Regulations 2005 [2] and their accompanying guidance [3]. The legislation requires that exposure with hearing protection is not to exceed the limit levels.

Effective noise control at source should always be regarded as the prime means of affording proper protection to employees from risks to hearing. Circumstances might arise, however, where this is not reasonably practicable. On such occasions, employees should be provided with, and should wear, personal ear protectors.

It might be necessary for the tone and/or volume of warning signals to be modified or for additional steps to be taken to alert employees to hazards in areas where personal ear protectors are used. Checks will be necessary, when sound warning signals are used, to ensure that the signals can be heard and orientated by employees wearing ear protectors.

5.4 Noise-induced stress

Noise can interfere with working efficiency by inducing stress, by disturbing concentration and by increasing accident risk. Effects of noise on persons on site are similar to, albeit far greater than, the effects on nearby residents, and the benefits of good control measures will apply equally on and off site.

6 Neighbourhood nuisance

NOTE Example criteria for the assessment of the $\overline{A_1}$ potential significance $\overline{A_1}$ of noise effects are given in Annex E.

6.1 Disturbing effects of noise

The effects of noise on noise-sensitive premises (NSPs) are varied and complicated. They include interference with speech communication, disturbance of work or leisure activities, disturbance of sleep, annoyance and possible effects on mental and physical health. In any neighbourhood, some individuals will be more sensitive to noise than others.

6.2 Environmental noise descriptor

The A-weighted sound pressure level, L_{pAr} will give an indication of the loudness of noise at a NSP. However, some of the effects mentioned in 6.1 are dependent not only upon loudness; attitudinal and other factors are also important.

A measure that is in general use and is recommended internationally for the description of environmental noise is the equivalent continuous A-weighted sound pressure level, $\overline{A_1} L_{Aeq, T} \overline{A_1}$. The time period, T (e.g. 1 h, 12 h), involved (see 3.7) should always be stated.

When describing noise from isolated events that might not always be apparent from a longer period $\overline{A_1} L_{Aeq, T} \overline{A_1}$, it can be useful to use a short period (e.g. 5 min) $\overline{A_1} L_{Aeq, T} \overline{A_1}$. Alternatively, the maximum sound level, $\overline{A_1} L_{Amax} \overline{A_1}$, or the one percentile level, $\overline{A_1} L_{A01, T} \overline{A_1}$, can be used.

Whichever measure is used to describe environmental noise, it should always be made clear to which period of the day any particular value of the measure applies.

Annex F deals with the estimation of site noise and Annex G is concerned with noise measurement and monitoring.

6.3 Issues associated with noise effects and community reaction

A number of factors are likely to affect the acceptability of noise arising from $\overline{A_1}$ construction and open sites $\overline{A_1}$ and the degree of control necessary. These are described as follows.

- a) *Site location.* The location of a site in relation to NSPs will be a major factor. The nearer a site is to NSPs, the more control that might be required upon noise emanating from the site.
- b) *Existing ambient noise levels.* Experience of complaints associated with industrial noise sources indicates that the likelihood of complaint increases as the difference between the industrial noise and the existing background noise increases. Some types of open sites, such as quarries and landfill sites, are usually assessed in this manner. For some large infrastructure projects that require an environmental statement to be prepared, construction noise is sometimes assessed by comparing the predicted construction noise (plus ambient noise) with the pre-construction ambient noise.

However, it is generally assumed that a greater difference might be tolerated, than for an industrial source, when it is known that the operations are of short or limited duration, and the critical issues are likely to include interference with speech communication and/or sleep disturbance.

- c) *Duration of site operations.* In general, the longer the duration of activities on a site, the more likely it is that noise from the site will prove to be an issue, assuming NSPs are likely to be significantly affected. In this context, good public relations and communication are important. Local residents might be willing to accept higher levels of noise if they know that such levels will only last for a short time. It is then important that construction activities are carried out in accordance with the stated schedule and that the community is informed of their likely durations. (See also 8.5.2.3.)
- d) *Hours of work.* For any NSP, some periods of the day will be more sensitive than others. For example, levels of noise that would cause speech interference in an office during the day would cause no problem in the same office at night. For dwellings, times of site activity outside normal weekday and Saturday morning working hours will need special consideration. Noise control targets for the evening period in such cases will need to be stricter than those for the daytime and, when noise limits are set, the evening limit might have to be as much as 10 dB(A) below the daytime limit. Very strict noise control targets might need to be applied to any site which is to operate at night; this will depend on existing ambient noise levels. The periods when people are getting to sleep and just before they wake are particularly sensitive. (See also 8.5.2.4.)
- e) *Attitude to the site operator.* It is well established that people's attitudes to noise can be influenced by their attitudes to the source or activity itself. Noise from a site will tend to be accepted more readily by local residents, if they consider that the contractor is taking all possible measures to avoid unnecessary noise. The attitude to the contractor can also be improved through good community liaison and information distribution and the provision of a helpline to respond to queries or complaints. The acceptability of the project itself can also be a factor in determining community reaction.
- f) *Noise characteristics.* In some cases a particular characteristic of the noise, e.g. the presence of impulses or tones, can make it less acceptable than might be concluded from the level expressed in terms of $L_{Aeq,T}^{(A)}$. This is because these characteristics are likely to make the noise more disturbing than a noise with the same $L_{Aeq,T}^{(A)}$ level that does not have these characteristics. Examples would be impulsive noise from driven piling, rattling type noise from vibratory rollers, machine reversing alarms, etc.

$\square^{(A)}$ List item g) deleted $\square^{(A)}$

$\square^{(A)}$ NOTE Information regarding the provision of mitigation is given in Annex E. $\square^{(A)}$

7 Project supervision

7.1 General

The intention throughout any construction programme should be to minimize levels of site noise whilst having due regard to the practicability and economic implication of any proposed control or mitigation measures.

Planners, developers, architects, engineers and environmental health officers can all assist in preventing excessive noise levels. Prevention can be achieved by giving careful consideration to the plant, processes, activities and programme associated with any construction project.

NOTE The Construction (Design and Management) Regulations 2007 [4] came into effect on 6 April 2007. They replaced the Construction (Design and Management) Regulations 1994 [5] and the Construction (Health, Safety and Welfare) Regulations 1996 [6]. An Approved Code of Practice [7] provides practical guidance on complying with the duties set out in the Regulations.

The key aim of these are to integrate health and safety into the management of the project and to encourage everyone involved to work together to:

- a) *improve the planning and management of projects from the very start;*
- b) *identify risks early on so that they can be eliminated or reduced at the design or planning stage and the remaining risks can be properly managed;*
- c) *target effort where it can do the most good in terms of health and safety; and*
- d) *discourage bureaucracy.*

Developers, architects and engineers will need to know whether the processes they intend using are likely to result in excessive noise and/or vibration levels. Therefore early consultation should be made with local authorities in order to ascertain the limits or restrictions, if any, likely to be imposed; before seeking consultation, the expected levels of site noise should be determined. Annexes C and D give typical noise levels created by site plant and activities, and Annex F gives guidance on estimating noise from sites.

Local authorities should ensure that any noise level limits or restrictions being imposed are necessary and practicable.

7.2 Works preparation

NOTE Additional guidance on planning site operations is given in CIRIA Report 120 [8].

A project design should be so arranged that the number of operations likely to be particularly disturbing is kept to a minimum. Designers should also remember that project designs can have considerable influence upon operators' use of sites. Project designs should include the location of items such as haulage roads, batching plants and generators.

Appropriate investigations into ground conditions should be made when preliminary surveys are being carried out in order that consideration can be given to methods of working which could avoid problems.

A survey of the immediate neighbourhood surrounding a site should be undertaken to indicate the location of sensitive areas.

Guidance should be sought concerning recommended noise levels for the neighbourhood surrounding a site, and concerning acceptance of the proposed methods of working, in very general terms, from the relevant authorities at the same time as approvals are being requested for the commencement of work. This procedure is intended to enable work to proceed smoothly.

When works involve a tender stage, details of consents or other restrictions should be given to tenderers as early as possible.

When a number of site operators will be working on one site, overall site operations should be coordinated. Preferred routes for off-site movement of vehicles should be established with the local highway authority and the police. Access traffic should be routed away from NSPs.

Tenderers for a project should select the most appropriate plant in order that limits will not be exceeded. They should also be aware of the extent of control measures that will be necessary so that appropriate cost allowances can be made.

Tenderers should satisfy themselves that proposed methods of working and phasing of operations will meet the local authority's requirements. They should be clear about this before submitting their tenders.

Tenderers should take due regard of the following before tendering:

- a) site layout, e.g. location of static noise sources, and use of site buildings, material dumps, etc., as ad hoc barriers;
- b) types of machinery likely to be used and whether alternative types or techniques would achieve less disturbance.

7.3 Execution of works

NOTE The use of "best practicable means" (BPM) to control emissions can constitute a ground of defence against charges that a nuisance is being caused under Part III of the Control of Pollution Act 1974 [9] or Part III of the Environmental Protection Act 1990 [10].

All available techniques should be used to minimize, as far as is appropriate, the level of noise to which operators and others in the neighbourhood of site operations will be exposed.

Measures which should be taken include the following.

- a) The hours of working should be planned and account should be taken of the effects of noise upon persons in areas surrounding site operations and upon persons working on site, taking into account the nature of land use in the areas concerned, the duration of work and the likely consequence of any lengthening of work periods.
- b) Where reasonably practicable, quiet working methods should be employed, including use of the most suitable plant, reasonable hours of working for noisy operations, and economy and speed of operations. Site work continuing throughout 24 h of a day should be programmed, when appropriate, so that haulage vehicles will not arrive at or leave the site between 19.00 h and 07.00 h. On tunnel sites, for example, it is common practice to provide night-time storage areas for soil and debris.
- c) Noise should be controlled at source and the spread of noise should be limited, in accordance with Clause 8.

- d) On-site noise levels should be monitored regularly, particularly if changes in machinery or project designs are introduced, by a suitably qualified person appointed specifically for the purpose. A method of noise measurement should be agreed prior to commencement of site works. If this is not specified, the method used should be one of those described in Annex G.
- e) On those parts of a site where high levels of noise are likely to be a hazard to persons working on the site, prominent warning notices should be displayed and, where necessary, ear protectors should be provided (see also Clause 5).

When potential noise problems have been identified, or when problems have already occurred, consideration should be given to the implementation of practicable measures to avoid or minimize those problems. Local authorities, consulting with developers and their professional advisers or with site operators, will need to consider the extent of noise control measures necessary to prevent the occurrence of significant problems, and will also need to consider whether the implementation of those measures will be practicable. Local authorities might wish to consider whether to specify quantified limits on site noise and whether, additionally or instead, to lay down requirements relating to work programmes, plant to be used, siting of plant, periods of use, working hours, access points, etc. The latter approach will often be preferable in that it facilitates the monitoring of formally or informally specified requirements, both for the authorities and for the site operators.

7.4 Emergencies

NOTE Attention is drawn to Section 61 of the Control of Pollution Act 1974 [9], which requires provision to be made for emergencies (see A.3.3.3).

In the event of any emergency or unforeseen circumstances arising that cause safety to be put at risk, it is important that every effort be made to ensure that the work in question is completed as quickly and as quietly as possible and with the minimum of disturbance to people living or working nearby. The local authority should be informed as soon as possible if it is found necessary to exceed permitted noise limits because of an emergency.

8 Control of noise

8.1 General

NOTE 1 Guidance on groundborne noise from sub-surface construction activities is given in BS 5228-2:2009, 8.7.

Construction and demolition works can pose different noise control problems compared with most other types of industrial activity for the following reasons:

- they are mainly carried out in the open;
- they are of temporary duration although they can cause great disturbance while they last;
- the noise they make arises from many different activities and kinds of plant, and its intensity and character can vary greatly at different phases of the work; and
- the sites cannot be excluded by planning control, as factories can, from areas that are sensitive to noise.

If a site upon which construction or demolition work will be carried out involves an existing operational railway, special features that are

NOTE 2 EC Directive 2000/14/EC [11] deals with noise from particular sources, for example, many categories of construction plant and equipment.

significant in relation to noise control have to be taken into account. Advice should be sought in such cases from the appropriate railway authorities.

Much of the noise from construction and demolition sites is generated by plant and machinery. The noise levels so generated are unacceptable in many instances and reductions are necessary for the benefit of both the industry and the public.

8.2 Control of noise at source

8.2.1 General

NOTE Attention is drawn to regulatory requirements contained within the Health and Safety at Work etc Act 1974 [12], the Workplace (Health, Safety and Welfare) Regulations 1992 [13] and the Management of Health and Safety at Work Regulations 1992 [14] in respect of reversing warning systems.

There are many general measures that can reduce noise levels at source such as:

- a) avoid unnecessary revving of engines and switch off equipment when not required;
- b) keep internal haul routes well maintained and avoid steep gradients;
- c) use rubber linings in, for example, chutes and dumpers to reduce impact noise;
- d) minimize drop height of materials;
- e) start up plant and vehicles sequentially rather than all together.

The movement of plant onto and around the site should have regard to the normal operating hours of the site and the location of any NSPs as far as is reasonably practicable.

The use of conventional audible reversing alarms has caused problems on some sites and alternatives are available. Audible reversing warning systems on mobile plant and vehicles should be of a type which, whilst ensuring that they give proper warning, have a minimum noise impact on persons outside sites. When reversing, mobile plant and vehicles should travel in a direction away from NSPs whenever possible. Where practicable, alternative reversing warning systems should be employed to reduce the impact of noise outside sites.

8.2.2 Specification and substitution

Where a construction site is within a noise-sensitive area, the plant and activities to be employed on that site should be reviewed to ensure that they are the quietest available for the required purpose; this is in accordance with best practicable means. For an existing operational site, where reasonably practicable, noisy plant or activities should be replaced by less noisy alternatives (see Annex B for examples) if noise problems are occurring.

8.2.3 Modification of existing plant and equipment

Noise from existing plant and equipment can often be reduced by modification or by the application of improved sound reduction methods, but this should only be carried out after consultation with the manufacturer. Suppliers of plant will often have ready-made kits available and will often have experience of reducing noise from their plant.

For steady continuous noise, such as that caused by diesel engines, it might be possible to reduce the noise emitted by fitting a more effective exhaust silencer system or by designing an acoustic canopy to replace the normal engine cover. Any such project should be carried out in consultation with the original equipment manufacturer and with a specialist in noise reduction techniques. The replacement canopy should not cause the engine to overheat nor interfere excessively with routine maintenance operations.

It might be possible in certain circumstances to substitute electric motors for diesel engines, with consequent reduction in noise. On-site generators supplying electricity for electric motors should be suitably enclosed and appropriately located.

Noise caused by resonance of body panels and cover plates can be reduced by stiffening with additional ribs or by increasing the damping effect with a surface coating of special resonance damping material. Rattling noises can be controlled by tightening loose parts and by fixing resilient materials between the surfaces in contact; this is generally a maintenance issue.

Impact noise during steel construction can be a nuisance. Direct metal-to-metal contact should be minimized.

8.2.4 Enclosures

As far as reasonably practicable, sources of significant noise should be enclosed. The extent to which this can be done depends on the nature of the machine or process to be enclosed and their ventilation requirements.

Materials suitable for constructing enclosures are listed in Annex B, which also includes a design for an acoustic shed. When it is necessary to enclose a machine or process and its operator(s) in an acoustic enclosure or building, precautions should be taken to protect the operator(s) from any consequential hazard.

The effectiveness of partial noise enclosures and of screens can be reduced if they are used incorrectly, e.g. the noise being enclosed should be directed into and not out of enclosures. There should not be a reflecting surface, such as a parked lorry, opposite the open side of noise enclosures. Any openings in complete enclosures, e.g. for ventilation, should be effectively sound-reduced.

8.2.5 Use and siting of equipment

Plant should always be used in accordance with manufacturers' instructions. Care should be taken to site equipment away from noise-sensitive areas. Where possible, loading and unloading should also be carried out away from such areas. Special care is necessary when work has to be carried out at night but it might be possible to carry out quiet activities during that time.

Machines such as cranes that might be in intermittent use should be shut down between work periods or should be throttled down to a minimum. Machines should not be left running unnecessarily, as this can be noisy and wastes energy.

Plant from which the noise generated is known to be particularly directional should, wherever practicable, be orientated so that the

noise is directed away from noise-sensitive areas. Acoustic covers to engines should be kept closed when the engines are in use and idling. If compressors are used, they should have effective acoustic enclosures and be designed to operate when their access panels are closed.

Materials should be lowered whenever practicable and should not be dropped. The surfaces on to which the materials are being moved should be covered by resilient material.

When a site is in a residential environment, lorries should not arrive at or depart from the site at a time inconvenient to residents.

In certain types of piling works there will be ancillary mechanical plant and equipment that might be stationary, in which case care should be taken in location, having due regard also for access routes. Stationary or quasi-stationary plant might include, for example, support fluid preparation equipment, grout or concrete mixing and batching machinery, lighting generators, compressors, welding sets and pumps. When appropriate, screens or enclosures should be provided for such equipment. Additional mitigation might be required at night, e.g. by moving plant away from sensitive areas to minimize disturbance to occupants of nearby premises.

8.2.6 Maintenance

Regular and effective maintenance by trained personnel is essential and will do much to reduce noise from plant and machinery. Increases in plant noise are often indicative of future mechanical failure.

Sound-reducing equipment can lose its effectiveness before failure is indicated by visual inspection.

Noise caused by vibrating machinery having rotating parts can be reduced by attention to proper balancing. Frictional noise from the cutting action of tools and saws can be reduced if the tools are kept sharp. Noises caused by friction in conveyor rollers, trolleys and other machines can be reduced by proper lubrication.

8.3 Controlling the spread of noise

8.3.1 General

If noisy processes can be avoided, then the amount of noise reaching the noise-sensitive area will be reduced. Alternative ways of doing this are either to increase the distance between the noise source and the sensitive area or to introduce noise reduction screens, barriers or bunds.

8.3.2 Distance

Increasing the distance from NSPs is often the most effective method of controlling noise. This might not be possible when work takes place on a restricted site or fixed structures, e.g. railway tracks. The effect of distance on noise attenuation is explained in Annex F.

Stationary plant such as compressors and generators should be located away from any noise-sensitive area.

8.3.3 Screening

On sites where it is not possible to reduce a noise problem by increasing the distance between the source and receiver, screening might have to be considered. For maximum benefit, screens should be close either to the source of noise (as with stationary plant) or to the listener. Careful positioning of noise barriers, such as bunds or noise screens, can bring about significant reductions in noise levels, although account should be taken of the visual impact of such barriers. Planting of shrubs or trees can have a beneficial psychological effect but will do little to reduce noise levels unless the planting covers an extensive area. Annex F gives information on the noise attenuation to be expected from typical barriers. If possible, decisions as to the most suitable types of screening should be made at project planning stages, because it will often be found that a site layout can itself contribute quite effectively towards the provision of useful screening. It might be necessary for safety reasons to place a hoarding around the site, in which case it should be designed taking into consideration its potential use as a noise screen. Removal of a direct line of sight between source and listener can be advantageous both physically and psychologically.

Site buildings such as offices and stores can be grouped together to form a substantial barrier separating site operations and nearby NSPs. On some sites, stacks of certain materials such as bricks, aggregate, timber or top soil can be strategically placed to provide a barrier. Areas which have been excavated below ground level such as basements or river works can be used to position static plant such as generators, compressors and pumps. This is a useful and often necessary method of reducing noise from plant that is required to operate continually day and night. Mechanical plant operating in confined spaces should be adequately ventilated, to allow for fume dispersal and to provide cooling air. Safety issues should be taken into account.



Earth bunds can be built to provide screening for major earth-moving operations and can be subsequently landscaped to become permanent features of the environment when works have been completed. The construction of a bund can be a noisy activity and should be planned carefully, e.g. it might be possible to construct the outer side of the bund first so that remaining work on the bund is shielded from NSPs. When earth barriers are not practicable due to lack of space, it might be possible for protective features ultimately needed as permanent noise screening to be built in during the early stages of site work. Such an approach is particularly pertinent to major road construction works.

The effectiveness of a noise barrier will depend upon its length, effective height, position relative to the noise source and to the sensitive area, and the material from which it is constructed. Further guidance on this is given in Annex B.

8.4 Noise control targets

NOTE 1 Section 60 of the Control of Pollution Act 1974 [9] specifies the matters to which local authorities will have regard when serving a notice imposing requirements to limit noise and vibration emission from sites.

NOTE 2 Annexes C and D give guidance on noise levels produced by site equipment and activities, and Annex F describes methods of estimating noise from construction sites. The information contained in these annexes is intended to assist with the prediction of the levels of noise likely to emanate from a proposed construction site and to provide a useful reference when the setting of noise limits is being considered.

NOTE 3  Specific limits for noise from surface mineral extraction and production for England are detailed in the Technical Guidance to the National Planning Policy Framework [15]; there are no similarly defined limits for Scotland or Wales. 

NOTE 4 Joint monitoring between the site operator and the local authority is possible.

All reasonably practicable means should be employed to ensure the protection of local communities and of people on construction sites, from detrimental effects of the noise generated by construction operations. The means employed should be determined by local circumstances and can include the methods described in 8.2 and 8.3.

Those seeking to determine suitable noise control targets for construction operations should be aware of the particular noise problem that can occur when such operations take place in existing buildings that are either occupied or contiguous with occupied buildings. Vibration introduced directly into the structure by equipment such as breakers, hammers and drills might attenuate only slowly as it is transmitted through the structure and might therefore produce unacceptable levels of noise in rooms remote from the source. In particularly sensitive situations, it might be necessary to use alternative techniques and equipment. (See also 6.3.)

Monitoring of noise at sites where noise is an issue should be regarded as essential. Measurement may be carried out for a number of reasons, including the following:

- a) to allow the performance of noise control measures to be assessed;
- b) to ascertain noise from items of plant for planning purposes;
- c) to provide confirmation that planning requirements have been complied with.

Monitoring positions should reflect the purpose for which monitoring is carried out.

Monitoring to ascertain whether an item of plant or particular process is meeting an anticipated noise criterion or if noise control methods are working, might require measurements to be carried out close to the plant or process to avoid undue interference from other noise sources.

Monitoring to confirm that planning conditions imposed to protect local occupants have been met may be undertaken at NSPs or at the site boundary, with a correction applied. The choice of noise measurement locations to be included in the planning conditions should reflect the requirement to accurately assess the noise.

Monitoring is the responsibility of the site operator and should be carried out by suitably trained personnel.

8.5 Noise control from piling sites

8.5.1 General

Increased mechanization has meant the use of more powerful and potentially noisier machines. Noise levels can be unacceptable in many instances, and reductions in noise level are desirable for the benefit of both the industry and the public. Piling works frequently form one of the noisier aspects of construction. The trend towards medium and high rise structures, particularly in urban areas, coupled with the necessity to develop land which was hitherto regarded as unfit to support structures, has led to increasing use of piled foundations. Piling is usually one of the first activities to be carried out on site,

and special precautions should be taken to mitigate the disturbance created, particularly in noise-sensitive areas.

Guidance on types of piling is given in Annex H.

Those undertaking piling works should endeavour to ascertain the nature and levels of noise produced by the mechanical equipment and plant that will be used (see Tables C.3, C.12, D.4 and D.5). They should then take appropriate steps to reduce either the level or the annoying characteristics, or both, of the noise, following the recommendations given in 8.3.3.

Impact noise when piling is being driven can be reduced by introducing a non-metallic dolly between the hammer and the driving helmet. This will prevent direct metal-to-metal contact, but will also modify the stress wave transmitted to the pile, possibly affecting the driving efficiency. The energy absorbed by the dolly will appear as heat. Further noise reduction can be achieved by enclosing the driving system in an acoustic shroud. Several commercially available systems employ a partial enclosure arrangement around the hammer. It is also possible to use pile driving equipment that encloses the hammer and the complete length of pile being driven, within an acoustic enclosure.

8.5.2 Factors to be considered when setting noise control targets

NOTE 1 The construction industry is generally innovative and constantly developing, and there might be proprietary systems available at the time of tender that were not known or available at the planning stage.

NOTE 2 Factors that can affect the acceptability of noise and the degree of mitigation required are described in 6.3. The present subclause provides information specifically related to piling works and should be read in conjunction with 6.3.

8.5.2.1 Selection of piling method

NOTE Examples of typical noise levels associated with the different methods of piling are given in Tables C.3, C.12, D.4 and D.5.

The selection of a method to be used for the installation of piles will depend on many factors (see Annex H for types of piling). A decision regarding the type of pile to be used on a site should not be governed solely by noise, but should also take into account criteria such as loads to be carried, strata to be penetrated and the economics of the system, e.g. the time it will take to complete the installation and other associated operations such as soil removal. In some cases, adjacent land uses can play a significant role in the choice of piling technique, e.g. due to the effects of noise.

It might not be possible for technical reasons to replace a noisy process by a quieter alternative. Even if it is possible, the adoption of a quieter method might prolong the piling operation; the net result being that the overall disturbance to the community, not only that caused by noise, will not necessarily be reduced.

8.5.2.2 Types of noise

On typical piling sites the major sources of noise are mobile. Therefore, the noise received at any control points will vary from day to day as work proceeds.

The type of noise associated with piling works depends on the method of piling employed. For example, pile driving using a drop hammer results in a well-defined, impulsive noise. Air and diesel hammers also produce impulsive noise although their striking rates can be much higher than with drop hammers. With bored or pressed-in piling methods the resultant noise is continuous rather than impulsive.

Highly impulsive noise is generally less acceptable than steady noise. However, other characteristics of the noise source play an important part in determining the acceptability of piling noise, e.g. cable slap, screeching of pulleys and guides, clanking of locking kelly bars, and ringing of piles.

8.5.2.3 Duration of piling works

NOTE See also 6.3c).

The duration of piling work is usually short in relation to the length of construction work as a whole, and the amount of time spent working near to noise-sensitive areas might represent only a part of the piling period. Furthermore, the noisiest part of the pile construction process might occur at each individual pile location only for a short period of time.

8.5.2.4 Hours of work

NOTE See also 6.3d).

When noise impacts are to be controlled by imposing restrictions on working hours the specialized nature of some piling works should be considered, which might necessitate a longer working day. This is especially necessary for large diameter concrete bored piles and diaphragm walls.

Additionally, the acceptable hours for the residents and occupiers of a particular area should also be considered.

Developers should have regard to likely restrictions to be placed on them when considering piling techniques, and should liaise with local authorities at an early stage.

8.5.2.5 Methods of monitoring and control on piling sites

Whatever method is appropriate for the specifying of a noise target, there should be agreement between the piling contractor concerned and the controlling authority. It is essential that a noise target is appropriate to the type of noise, and is practical and enforceable. It should adequately protect the community but allow work to proceed without placing undue restriction on the activities.

Steady noise levels should normally be expressed in terms of the $L_{Aeq,T}^{A1}$ over a period of several hours or for a working day. Impulsive noise levels cannot always be controlled effectively using this measure alone. The specification of a higher short-term limit is often found useful. This can be achieved by specifying a short period $L_{Aeq,T}^{A1}$ or the one percentile exceedance level $L_{A01,T}^{A1}$ over one driving cycle or the L_{Amax}^{A1} . Where $L_{A01,T}^{A1}$ or L_{Amax}^{A1} is specified, the F time weighting should be used.

The difference between limits set in terms of $L_{A01,T}^{A1}$ and $L_{Aeq,T}^{A1}$ will depend on the striking rate of the pile driver.

Those who wish to use the data for $L_{Aeq,T}(A_1)$ in Annexes C and D to estimate the corresponding value of $L_{A01,T}(A_1)$ should note the following approximate relationships [all measurements in dB(A)]:

- a) $L_{A01,T}(A_1) = L_{Aeq,T}(A_1) + 11$ for pile drivers such as drop hammers with a slow striking rate (typically 20 to 25 blows per minute);
 - b) $L_{A01,T}(A_1) = L_{Aeq,T}(A_1) + 9$ for pile drivers using hydraulic hammers with an intermediate striking rate (typically 40 to 50 blows per minute);
- and
- c) $L_{A01,T}(A_1) = L_{Aeq,T}(A_1) + 5$ for air hammers with a fast striking rate (typically more than 80 blows per minute).

There are no general empirical relationships between $L_{Amax}(A_1)$ and $L_{Aeq,T}(A_1)$.

The monitoring of noise might not be required if it can be demonstrated by calculation or manufacturer's data that the chosen method of pile installation will not exceed the noise target. Annexes C and D provide guidance of measured noise levels for different piling methods. Annex C gives up-to-date guidance, whereas Annex D gives historic data tables taken from the 1997 edition of BS 5228-1 and the 1992 edition of BS 5228-4. The tables in Annex D are intended for use where no equivalent data exists in Annex C.

8.6 Noise control from surface coal extraction

8.6.1 General

Opencast coal sites can pose a greater diversity of problems of noise control compared with most other types of industrial activity for the following reasons.

- a) Apart from some ancillary operations, they are carried out entirely in the open and can extend over a wide area.
- b) They are of variable duration from a few months to several years, and in some cases sites in adjacent areas can follow one another in succession over a prolonged period.
- c) A wide variety of activities are carried out involving the following phases:
 - 1) geological and geotechnical exploration;
 - 2) preliminary operations to establish the site;
 - 3) soil stripping and removal of overburden;
 - 4) coaling, coal preparation, storage and dispatch;
 - 5) backfilling and final site restoration;
 - 6) rehabilitation of final land form to public amenity, agriculture or other subsequent development.
- d) A wide range of earth-moving and specialized plant is employed, the use of which varies significantly at different phases and times and at different heights and depths within the site.

Prior to making an application for planning permission, an applicant should discuss with the Mineral Planning Authority (MPA) and the appropriate department of the local authority (see Annex A)

the predicted noise levels from the proposed site and the control measures to be implemented. This will highlight at an early stage any noise and vibration issues that need to be addressed. The predicted noise levels and proposed control measures should be included in the application documentation.

Local residents and other interested parties should also be consulted at this stage.

8.6.2 Site planning

In planning the working of the site, account should be taken of the effect of the proposed working method and site layout on adjacent NSPs. Where necessary, alternative methods or arrangements which have the least noise impact should be employed if economically viable.

8.6.3 Location of site elements

With due consideration of the topography of the area and natural screening effects, care should be taken in the siting of the following:

- a) access points;
- b) limit of excavation;
- c) baffle mounds;
- d) acoustic fences;
- e) overburden mounds;
- f) internal haul roads;
- g) plant yards and maintenance facilities;
- h) coal screening and washing plants;
- i) pumps, generators and static plant;
- j) stocking areas and loading facilities;
- k) off-site coal haulage routes; and
- l) site amenities and car parking.

NOTE The location and design of access points have to be agreed with the highway authority and the Mineral Planning Authority.

Access points should be located with due regard to the proximity of NSPs.

The limit of excavation is determined by a wide range of geological and engineering constraints such as the location, nature and quality of the coal, the characteristics and stability of the strata and the existence of faults and other features. In addition to these constraints, further reductions to the limit of excavation should be considered where necessary, e.g. to provide additional space around the excavation area for baffle mounds or other screening methods or to utilize fully the natural screening effects of the existing topography.

Baffle mounds should be sited so as to provide protection to NSPs and should be extended in length beyond the limits of the premises to be protected. To obtain the best protection, they should be sited to obscure the line of sight to the noise sources and to maximize the path differences. Guidance on the noise reduction to be expected from baffle mounds and similar barriers is given in Annex F.

Where protection to NSPs is required, and where construction of a baffle mound is impracticable, the provision of another type of acoustic barrier should be considered where appropriate. Visual considerations should be taken into account.

Due to the highly visible and intrusive nature of operations involved in the construction and removal of overburden mounds, they should always be sited as far from NSPs as possible unless they provide acoustic benefits that are necessary. Their height should be restricted where necessary to avoid visual issues.

During construction of an overburden mound, the faces nearest to NSPs should be progressively raised to form an effective baffle so that the bulk of tipping is carried out behind those faces. Similarly, those faces should be retained for as long as practicable during removal of the mounds to provide screening for the bulk of the removal operations.

Internal haul roads should be located as far as practicable from NSPs and should be appropriately screened. The roads should have easy gradients and gradual turns to reduce noise emission from vehicles and mobile plant.

Overburden mounds should be located as far from NSPs as is reasonably practicable, except where they are used as baffle mounds.

Site amenities, plant yards, maintenance areas, coal screening/washing plants, stocking and loading facilities should be sited as far from NSPs as practicable and should be screened from NSPs.

Where coal is to be transported from the site by road, the route should be carefully selected to minimize the impact on NSPs even if this results in an increased haulage distance.

8.6.4 Working methods

The phasing of the works and the working methods will have a major bearing on the control of noise. The following factors will have a particularly significant effect:

- a) depth of the coal seams;
- b) direction of working;
- c) height, method of construction and location of overburden mounds;
- d) location, gradient and screening of site roads;
- e) plant to be employed;
- f) working hours;
- g) rate of production;
- h) use and control of blasting.

Working methods should be adopted that allow for early screening of NSPs from the subsequent operations. Where practicable, noisy static site elements should be located to take advantage of the screening effects of overburden and soil mounds.

Once the limit of excavation and the maximum depth of the coal seams to be extracted have been determined (see **8.6.3**), a direction of working and phasing of operations should be deployed that reduces the transmission of noise from the site.

There is a wide range of variables that influence these activities, therefore it is not possible to be prescriptive for individual sites and a common sense approach should be adopted. For example, it might be useful to retain an area of high ground within an excavation area of a site to screen other site activities until the latter stages of a particular

phase of an operation, whereas in other cases the material from the high ground might be more effectively utilized as screening material in an earlier phase of the operation.

8.6.5 Selection of plant

The characteristics of noise emissions from each item of plant, and their collective effect, should be assessed during the selection process for the acquisition of plant. Where practicable, plant should be selected which will have the least impact in terms of noise. For example, where electric plant is to be deployed on site, a mains supply is likely to produce less noise than on-site generators. Information concerning sound power levels for specific items of plant is given in Tables C.6, D.10 and D.11.

8.6.6 Deployment of plant

The movement of plant on and off the site should be restricted as far as practicable to within the agreed working hours for the site.

The time taken to carry out noisy operations near occupied properties outside the site should be reduced to as short a period as possible.

8.6.7 Hours of work

The restriction of working hours for any operation where emissions of noise might have an adverse effect on the occupants of NSPs should be considered in preference to the sterilization of coal reserves. Coal haulage by road from such sites should be limited to between 07.00 h and 19.00 h, unless local circumstances require otherwise. However, working hours both for coal production and HGV activity on site are likely to be defined through conditions attached to the planning consent for the coal site.

8.6.8 Noise reduction

Noise sources likely to be encountered on site include trucks, loaders, dozers, excavators, sirens, screening and crushing plant, pumps, draglines, dumpers, drills and dredgers. Each site has its own particular characteristics so appropriate methods of noise reduction should be determined for each individual site. The general guidance on noise control given in 8.2 and 8.3 is applicable to surface coal extraction sites.

8.6.9 Blasting

Blasting can be an emotive issue for residents around an opencast site. Good liaison between operator and residents is essential to prevent unnecessary anxiety. Wherever possible, the operator should inform each resident of the proposed times of blasting and of any deviation from this programme in advance of the operations.

On each day that blasting takes place it should be restricted as far as practicable to regular periods.

Blasthole drilling can cause excessive noise emissions, particularly when carried out at or near ground level and close to the site boundary. The choice of appropriate drilling rigs, such as down-the-hole hammers or hydraulic drifters as opposed to compressed air drifters, will reduce the impact of noise emissions from this activity.

NOTE See also 6.3d).

Each blast should be carefully designed to maximize its efficiency and reduce the transmission of noise.

Initiation using detonating fuse on the surface can cause problems associated with air overpressure (see Annex I).

8.6.10 Coal disposal sites

After coal is excavated from an opencast site, it is sometimes taken to a coal disposal site. This can be located within an opencast site, adjacent to an opencast site or at some distance, near main line rail and road facilities, and can serve more than one site. At a coal disposal site any, all or a combination of the following can take place: coal washing, crushing, screening, blending, storage in hoppers or on the ground in bunds and dispatch from the disposal point by rail or road vehicles.

All of these activities generate noise. The major sources are the crushing and screening processes, the reception and disposal hoppers, mobile site plant and road and rail traffic.

Coal disposal sites are areas of major industrial activity and should be located at distance from noise-sensitive areas.

If there are any NSPs in close proximity, effective screening of mobile plant and traffic by baffle mounds is likely to be required, and appropriate provision should be made for the effective insulation of fixed plant and equipment, such as the use of lined chutes and properly designed acoustic enclosures.

8.6.11 Limitations on emissions of noise from sites

Opencast coal extraction and associated works can take place in remote to semi-urban areas. Each site and situation should be assessed for noise mitigation and control requirements based upon the specifics of the activity and the surrounding area. When the site is adjacent to NSPs, the MPA or Secretary of State can impose conditions including specific noise limits.

Guidance on criteria for the setting of noise control targets is given in Clause 6.

Limitations on working hours for the site, or part of it, and the restriction of the noisier activities to less sensitive times or days, can be employed as a means of limiting the impact of noise and vibration from opencast coal sites.

8.7 Noise control from surface mineral (except coal) extraction sites

Although there are some similarities with opencast coal extraction (see 8.6), surface mineral extraction sites can present different problems of noise control compared with most other industrial activity for the following reasons.

- a) Operations are to a large extent carried out entirely in the open.
- b) Activities are of variable duration, varying from a few months to many decades.

- c) On completion, surface mineral extraction sites are restored either to their original condition or to an appropriate state after use.
- d) A wide variety of activities, employing different types of plant, are carried out on surface mineral extraction sites. The intensity and character of any noise can vary at different phases of work, at different times and under differing conditions of, for example, topography, geology, climate and methods of operation. Particular problems have been encountered with audible warning signal devices such as sirens and audible reversing alarms.
- e) Minerals can only be worked where suitable resources exist. Resources might be present in close proximity to NSPs. Under these circumstances, such premises should be protected as far as is practicable from the adverse effects of noise.

A wide variety of different minerals is produced in Britain by surface extraction methods. These include natural and crushed sand, gravel and rock (sedimentary, igneous and metamorphic) produced as aggregates and building stone for the construction industry. In addition to some of the foregoing, slate, chalk, china clay, ball clay, fuller's earth, silica sands and various other minerals are essential raw materials to other British industries and world markets. The methods of working of each of these different materials vary greatly according to its type, the geology and location and the end uses for which the material is intended. The nature of any impacts from noise therefore need to be considered in the context of the relevant site-specific factors, bearing in mind the general advice contained in this clause.

As with coal sites, most of the noise from surface mineral extraction sites is generated by excavating plant, earth-moving plant, blasting activities, processing plant and other heavy traffic. Much of this plant is large and powerful but not necessarily noisy. Measures to control noise are generally necessary where sites are located in the vicinity of NSPs, for the benefit of both the public and the industry.

Blasting only occurs at a proportion of surface mineral extraction sites; generally only hard rock quarries. There are particular characteristics of blasting which require specific consideration of noise issues. Whilst drilling blast holes is associated with intermittent noise, blasting creates noise which is of very short duration, with a frequency of events varying from a small number per year to several times per day, depending on the nature and size of the extraction operation. Blasting results in airborne noise and groundborne vibration and both effects have more familiar parallels, for example, wind and thunder and pneumatic drills.

As with coal sites, typical mineral extraction operation involves stripping of topsoil and removal of overburden, excavation and processing of the material to be extracted, transportation of material within the site and to markets and subsequent restoration of the land. To allow specific work, e.g. soil stripping and baffle mound construction, to be carried out, higher noise level limits for short periods of time might need to be agreed. Guidance is given in [A1](#) the Technical Guidance to the National Planning Policy Framework [15] [A1](#). It might be preferable for occupants of NSPs to have a shorter, higher level of noise exposure than a longer term lower level noise exposure. The discussion and agreement of this with the Mineral Planning Authority (MPA) and local residents might be required.

NOTE 1 Further government guidance on these aspects is provided in [A1](#) the Technical Guidance to the National Planning Policy Framework [15] [A1](#).

NOTE 2 Guidance on noise from blasting is given in Annex I.

Criteria can be set from one or more of the following:

- 1) individual items of plant;
- 2) at the site boundary;
- 3) at local NSPs; and/or
- 4) at mutually agreed monitoring positions.

A correction factor (subtraction of 3 dB) is necessary to convert a measurement at a façade if the measurement is to be interpreted for the free field.

Annex A (informative) Legislative background

A.1 Statutory controls over noise and vibration

Citizens have a right to seek redress through common law action in the courts against the intrusion of unreasonable levels of noise or vibration which might affect their premises. In addition, there are two significant statutory remedies which enforcing authorities can employ to achieve the following two similar objectives:

- a) enforcement action to prevent or secure the abatement of a statutory nuisance; and
- b) use of specific national legislation to control noise and vibration from construction sites and other similar works.

Part III of the Environmental Protection Act 1990 [10] contains the mandatory powers available to local authorities within England and Wales in respect of any noise which either constitutes or is likely to cause a statutory nuisance. Section 79 of this Act defines statutory nuisance and places a duty on a local authority to inspect the area to detect any statutory nuisances which ought to be dealt with under Section 80. Under this section, where a local authority is satisfied of the existence, recurrence or likely occurrence of a statutory nuisance, it has to serve an abatement notice on the appropriate person or persons. Failure to comply with the terms of this notice is an offence which can result in proceedings in a Court of Summary Jurisdiction.

Section 82 of the Environmental Protection Act permits the court to act on a complaint by any person who might be aggrieved by the existence of a statutory nuisance and in these circumstances the court might follow the procedures described in the previous paragraph. Similar procedures to the above, for the control, in Scotland, of statutory nuisances caused by noise, are found under Sections 58 and 59 of the Control of Pollution Act 1974 [9]. In Northern Ireland the relevant equivalent provisions are contained in the Pollution Control and Local Government (Northern Ireland) Order 1978 [17].

Sections 60 and 61 of the Control of Pollution Act 1974 [9] give local authorities in England, Scotland and Wales special powers for controlling noise arising from construction and demolition works on any building or civil engineering sites. In Northern Ireland, equivalent powers are contained in the Pollution Control and Local Government (Northern Ireland) Order 1978 [17]. Powers under Sections 60 and 61 and their equivalent in Northern Ireland are confined to construction, including maintenance and repair, and to demolition works carried out on all building structures and roads. They are described in detail in **A.3.3**.

The statutory powers of local authorities to require the implementation of noise control measures remain the same whatever the character of the area within which the works are taking place, although the requirements will vary according to local circumstances.

Under Part III of the Control of Pollution Act 1974 [9], Section 71 requires the Secretary of State to approve a code of practice for the execution of works which come within the scope of Section 60.

A.2 European Commission (EC) directives

As part of its programme for the removal of barriers to trade (Article 100 of the Treaty of Rome) the EC has prepared directives which set noise emission levels for new items of construction equipment. The most recent of these, Directive 2000/14/EC [11] and Amending Directive 2005/88/EC [18], replaced a number of earlier directives, and have been implemented by regulations in the UK. Details of the directives and corresponding regulations are given in A.3.

A.3 UK Acts and Regulations

A.3.1 Health and Safety at Work etc. Act 1974

The protection of employed persons is covered by the Health and Safety at Work etc. Act 1974 [12].

Section 2 of the Act requires all employers to ensure, so far as is reasonably practicable, the health, safety and welfare at work of all their employees. Section 3 concerns employers' duties to persons not in their employment who might be exposed to health and safety risks. Section 6 requires designers, manufacturers, importers or suppliers to ensure, so far as is reasonably practicable, that articles for use at work are so designed and constructed as to be safe and without risks to health when properly used, that any necessary research to this end is carried out and that adequate information on the safe use of the articles is made available.

Section 7 places a duty on employees to take reasonable care for the health and safety of themselves and of other persons who might be affected, and to co-operate with their employers, so far as is necessary to enable any duty or requirement to be performed or complied with. In Northern Ireland, equivalent powers are contained in the Health and Safety at Work (Northern Ireland) Order 1978 [19].

A.3.2 Control of Noise at Work Regulations 2005

NOTE These regulations were made under the Health and Safety at Work etc Act 1974 [12].

The Control of Noise at Work Regulations 2005 [2] implement Directive 2003/10/EC [20].

The main requirements are triggered by four "action levels": daily personal noise exposures of 80 dB(A) and 85 dB(A) (the lower and upper exposure action levels respectively), and 135 dB(C) and 137 dB(C) (the lower and upper peak action levels respectively). There are also daily exposure and peak exposure limits of 87 dB(A) and 140 dB(C) respectively, which take into account the effect of wearing hearing protection and which the regulations do not allow to be exceeded. These regulations are concerned with the protection of people at work, and do not, therefore, deal with exposure to noise for the public.

Regulation 5 places a duty upon employers to carry out an assessment in the workplace to ascertain whether exposures are at or above the first action level. Such assessments are expected to identify which employees are exposed, and to provide enough information to

facilitate compliance with duties under Regulations 6, 7 and 10. Under Regulation 6, when any employee is exposed to levels at or above the upper daily exposure action level or upper peak exposure action level, the employer is required to reduce so far as is reasonably practicable, other than by the use of personal ear protection, the exposure to noise of that employee.

The provision of personal ear protection and the demarcation of hearing protection zones are covered by Regulation 7, and Regulation 9 introduces a specific duty on employers to carry out health surveillance including audiometric testing, where there is a risk to health.

Under Regulation 10, the employer has a duty to each employee who is likely to be exposed to the first action level and above, or to the peak action level or above, to provide adequate information, instruction and training on:

- a) the risks to that employee's hearing that such exposure might cause;
- b) what steps the employee can take to minimize that risk;
- c) the steps that the employee has to take in order to obtain personal ear protectors; and
- d) the employee's obligations under the Control of Noise at Work Regulations 2005 [2].

In Northern Ireland, equivalent powers are contained in the Control of Noise at Work Regulations (Northern Ireland) 2006 [21].

A.3.3 Control of Pollution Act 1974 and Environmental Protection Act 1990

A.3.3.1 General

The Control of Pollution Act 1974 [9] and the Environmental Protection Act 1990 [10] give local authorities powers for controlling noise and vibration from construction sites and other similar works. These powers can be exercised either before works start or after they have started. In Northern Ireland, similar provision is made in the Pollution Control and Local Government (Northern Ireland) Order 1978 [17]. Under the 1974 Act, contractors, or persons arranging for works to be carried out, also have the opportunity to take the initiative and ask local authorities to make their noise and vibration control requirements known. Because of an emphasis upon answering noise and vibration questions before work starts, implications exist for traditional tender and contract procedures (see **A.3.3.4**).

The procedures available under the Control of Pollution Act 1974 [9] for the control of construction noise are illustrated in the flow diagram shown in Figure A.1.

Figure A.1 Procedures to control construction noise under the Control of Pollution Act 1974

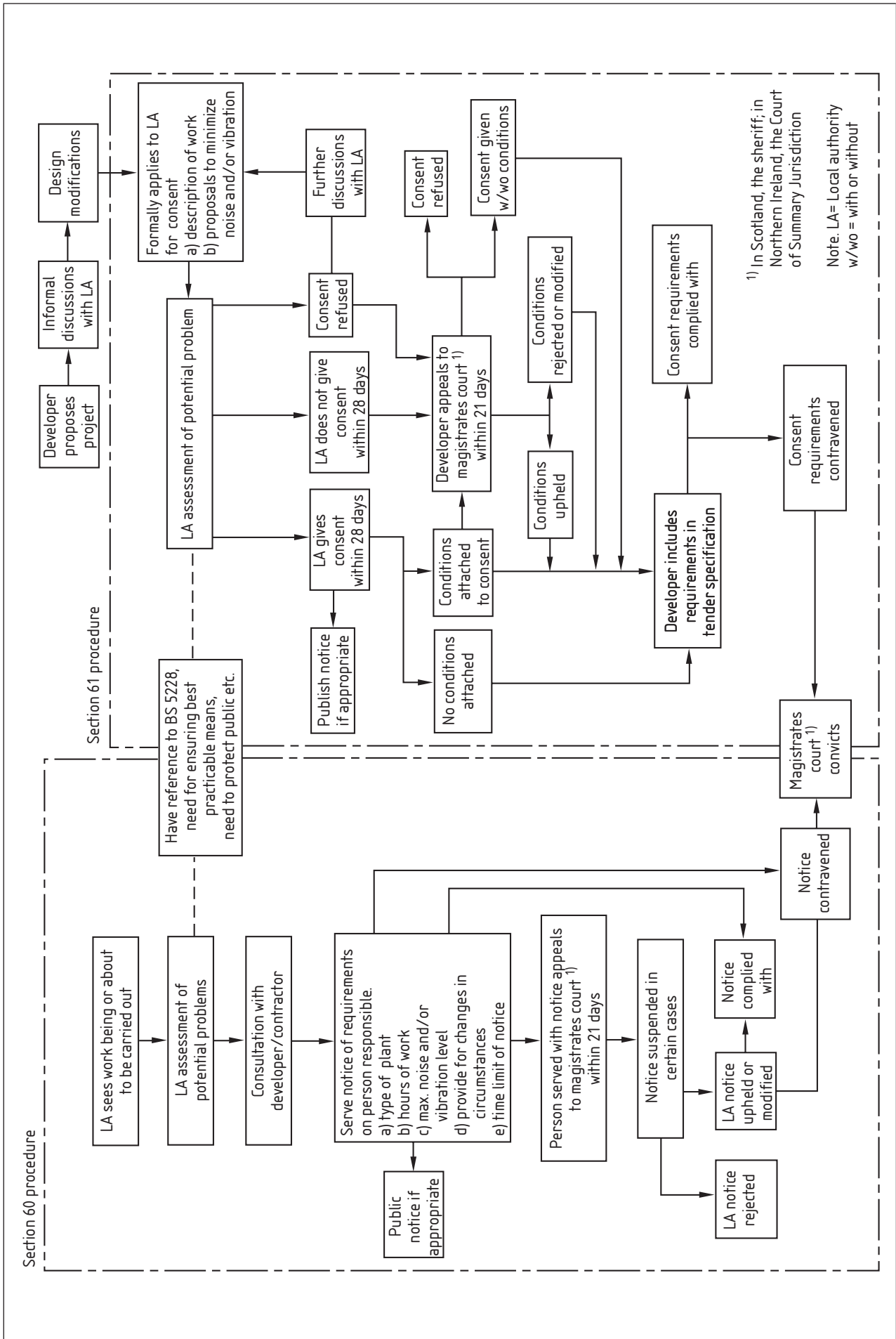

A.3.3.2 Notice under Section 60 of the Control of Pollution Act 1974

Section 60 of the Control of Pollution Act 1974 [9] enables a local authority, in whose area work is going to be carried out, or is being carried out, to serve a notice of its requirements for the control of site noise on the person who appears to the local authority to be carrying out the works and on such other persons appearing to the local authority to be responsible for, or to have control over, the carrying out of the works.

This notice can perform the following functions.

- a) Specify the plant or machinery that is or is not to be used. However, before specifying any particular methods or plant or machinery, the local authority has to consider the desirability, in the interests of the recipient of the notice in question, of specifying other methods or plant or machinery that will be substantially as effective in minimizing noise and vibration and that will be more acceptable to the recipient.
- b) Specify the hours during which the construction work can be carried out.
- c) Specify the level of noise and vibration that can be emitted from the premises in question or at any specified point on those premises or that can be emitted during the specified hours.
- d) Provide for any change of circumstances. An example of such a provision might be that if ground conditions change and do not allow the present method of working to be continued then alternative methods of working should be discussed with the local authority.

In serving such a notice, a local authority takes account of the following:

- 1) the relevant provisions of any code of practice issued and/or approved under Part III of the Control of Pollution Act 1974 [9];
- 2) the need for ensuring that the best practicable means are employed to minimize noise and vibration. "Best practicable means" recognizes that there are technical and financial limits on action that might reasonably be required to abate a nuisance;
- 3) other methods, plant or machinery that might be equally effective in minimizing noise and vibration, and be more acceptable to the recipient of the notice;
- 4) the need to protect people in the neighbourhood of the site from the effects of noise and vibration.

A person served with such a notice can appeal to a magistrates court or, in Scotland, a Sheriff or, in Northern Ireland, a Court of Summary Jurisdiction, within 21 days from the date of serving of the notice. Normally the notice is not suspended pending an appeal unless it requires some expenditure on works and/or the noise or vibration in question arises or would arise in the course of the performance of a duty imposed by law on the appellant. The regulations governing appeals also give local authorities discretion not to suspend a notice even when one or other of these conditions is met, if the noise is injurious to health, or is of such limited duration that a suspension would render the notice of no practical effect; or if the expenditure necessary on works is trivial compared to the public benefit expected.

The regulations governing appeals are:

- the Control of Noise (Appeals) Regulations 1975 [22];
- the Statutory Nuisance (Appeals) Regulations 1990 [23] as amended;
- in Northern Ireland, the Control of Noise (Appeals) Regulations (Northern Ireland) 1978 [24];
- in Scotland, the Control of Noise (Appeals) (Scotland) Regulations 1983 [25].

A.3.3.3 Consents under Section 61 of the Control of Pollution Act 1974

Section 61 of the Control of Pollution Act 1974 [9] concerns the procedure adopted when a contractor (or developer) takes the initiative and approaches the local authority to ascertain its noise and vibration requirements before construction work starts. (See also **A.3.3.2**.)

It is not mandatory for applications for consents to be made, but it will often be in the interest of a contractor or an employer or their agents to apply for a consent, because once a consent has been granted, a local authority cannot take action under Section 60 of the Control of Pollution Act 1974 [9] or Section 80 of the Environmental Protection Act 1990 [10], so long as the consent remains in force and the contractor complies with its terms. Compliance with a consent does not, however, mean that nuisance action cannot be taken under Section 82 of the Environmental Protection Act 1990 or under common law. A consent can be used as a defence in appeals against an abatement notice [Statutory Nuisance (Appeals) Regulations 1990 [23] as amended].

An application for a consent has to be made at the same time as, or later than, any request for approval under the Building Regulations 2000 [26], the Building Standards (Scotland) Regulations 1990 [27] or the Building Regulations (Northern Ireland) 2000 [28], or for a warrant under Section 6 of the Building (Scotland) Act 2003 [29], when this is relevant. Subject to this constraint, there are obvious advantages in making any application at the earliest possible date. There might be advantages in having informal discussions before formal applications are made.

An applicant for a consent is expected to give the local authority as much detail as possible about the works to which the application relates and about the method or methods by which the work is to be carried out. Information also has to be given about the steps that will be taken to minimize noise and vibration resulting from the works.

Provided that a local authority is satisfied that proposals (accompanying an application) for minimizing noise and vibration are adequate, it will give its consent to the application. It can, however, attach conditions to the consent, or limit or qualify the consent, to allow for any change in circumstances and to limit the duration of the consent. If a local authority fails to give its consent within 28 days of an application being lodged, or if it attaches any conditions or qualification to the consent that are considered unnecessary or unreasonable, the applicant concerned can appeal to a magistrates court within 21 days from the end of that period.

When a consent has been given and the construction work is to be carried out by a person other than the applicant for the consent, applicant is required to take all reasonable steps to bring the terms of consent to the notice of that other person; failure to observe the

terms of a consent is deemed to be an offence under the Control of Pollution Act 1974 [9].

Section 61 also requires provision to be made for emergencies.

A.3.3.4 Contractual procedures

It is likely to be to the advantage of a developer or contractor, or an employer or its agent, who intends to carry out construction or demolition work, to take the initiative and apply to the local authority for consents under the Control of Pollution Act 1974 [9].

An employer or its agent can choose to place the responsibility on the contractor to secure the necessary consents and can impose this requirement through formal contractual arrangements.

This could have implications for traditional tender and contract procedures because the local authority's noise and vibration requirements (in addition to any separate requirements defined by the employer) can be ill-defined at tendering and contract award stage. In these circumstances, any tendering contractor needs to endeavour to identify, quantify and accommodate the level of risk (in terms of both construction methodology and cost) prior to participating in the tendering process.

When a person for whom construction work is to be carried out has already sought and obtained consent from the local authority, the local authority's requirements need to be incorporated in the tender documents so that tenderers are aware of any apparent constraints arising from the consent.

A.3.4 Land Compensation Act 1973 (as amended), Highways Act 1980, Land Compensation (Scotland) Act 1973, Land Acquisition and Compensation (Northern Ireland) Order 1973

The Noise Insulation Regulations 1975 [30], Noise Insulation (Scotland) Regulations 1975 [31] and Noise Insulation (Northern Ireland) Regulations 1995 [32], made under the powers contained respectively in the Land Compensation Act 1973 [33], the Land Compensation (Scotland) Act 1973 [34] and the Land Acquisition and Compensation (Northern Ireland) Order 1973 [35], allow a highway authority to provide insulation for dwellings and other buildings used for residential purposes by means of secondary glazing and special ventilation when highway works are expected to cause serious noise effects for a substantial period of time. The 1973 Acts also contain provisions that enable a highway authority to pay the reasonable expenses of residents who, with the agreement of the authority, have to find suitable alternative accommodation for the period during which construction work makes continued occupation of an adjacent dwelling impracticable.

The Highways Act 1980 [36] and the Land Compensation (Scotland) Act 1973 [34] enable highway authorities to acquire land by agreement when its enjoyment is seriously affected by works of highway construction or improvement. In addition, these Acts give the highway authority power to carry out works, e.g. the installation of noise barriers, to mitigate the adverse effects of works of construction or improvement on the surroundings of a highway.

A.3.5 The Noise Insulation (Railways and Other Guided Transport Systems) Regulations 1995

The Noise Insulation (Railways and Other Guided Transport Systems) Regulations 1995 [37] give a discretionary power to railway authorities to provide insulation or grant for insulation where noise from the construction of a new or altered railway is expected seriously to affect residential and other buildings for a substantial time.

A.3.6 Other relevant UK legislation

A.3.6.1 Surface coal extraction by opencast methods

A1 Opencast coal mining is governed by legislative instruments and government policy. With regard to policy, guidance is contained in MPG 9 [40] on noise, blasting and vibration limits for blasting (as example conditions) and in the Technical Guidance to the National Planning Policy Framework [15] on noise limits for general minerals extraction and production. **A1**

The legislative framework consists of several elements, the most important of which is the Coal Industry Act 1994 [41]. Other key legislation includes the Coal Industry Nationalisation Act 1946 [42], the Opencast Coal Act 1958 [43], the Town and Country Planning Act 1990 [44] and the Planning and Compulsory Purchase Act 2004 [45].

Before 1984 the British Coal Corporation's sites were authorized by the Secretary of State for Energy. Since then for all opencast sites a planning permission has been required from the appropriate Mineral Planning Authority (MPA) or, on appeal or in respect of a call-in, from the Secretary of State for Communities and Local Government in England or the Scottish Minister for Scotland or the Minister for Environment, Planning and Countryside for Wales as appropriate.

Before making a planning application, the operator often undertakes extensive drilling and other explorations to prove the coal reserves. These operations are now governed by Clause 18 of the Town and Country Planning (General Development Procedure) Order 1995 [46]. Coal operators also require a licence from the Coal Authority if they wish to explore for coal.

NOTE Almost all coal in Great Britain is vested in the Coal Authority, a non-departmental public body created by the Coal Industry Act 1994 [41]. The authority is responsible for managing the non-operational aspects of the UK coal industry.

Since July 1988 almost all the British Coal Corporation's site applications and many larger sites applied for by other operators have been accompanied by an Environmental Statement. These are required under the Town and Country Planning (Environmental Impact Assessment) (England and Wales) Regulations 1999 [47]. The Environmental Statement examines the environmental implications of the proposed operations (noise, dust, visual impact, traffic, etc.) on the local community as well as the impact on the ecology and landscape of the site.

The MPA considers the application and, if satisfied that the proposals are acceptable in planning and environmental terms, approves it subject to conditions governing the site operations and restoration.

If the planning application is refused or not determined by the MPA, the operator can appeal to the Secretary of State for Communities and Local Government in England, the Minister for Environment, Planning and Countryside in Wales, or the Scottish Minister in Scotland, as appropriate. A public inquiry is held under an Inspector, and following the Inspector's report the Secretary of State in England or relevant Minister in Wales or Scotland, as appropriate, grants or refuses permission.

After an opencast site receives planning permission, an authorization from the local authority is also needed for the coal loading operations, which are Part B processes in accordance with the Regulations under Part 1 of the Environmental Protection Act 1990 [10].

All future coal mining operations will require a lease and licence from the Coal Authority under Part II of the Coal Industry Act 1994 [41]. Sites licensed by the British Coal Corporation before 31 October 1994 under Section 36 (2) of the Coal Industry Nationalisation Act 1946 [42] (as amended by the Coal Industry Act 1994), can, however, continue operations during the validity of those licences. Sites contained in the 1994 privatization packages have licences granted by the Government.

The previous limitation of 250 000 t on the amount of coal extracted from any one licensed opencast site was removed by the Coal Industry Act 1994.

Applicants for licences are responsible for securing the planning permission and other consents needed to work the coal, including rights to occupy the land and to disturb other minerals. Many opencast sites win significant quantities of other minerals, principally seams of fireclay beneath the coal seams. These operations also require planning permission.

A.3.6.2 Surface mineral extraction (except coal) sites

The principal legislation controlling the use of land for surface mineral extraction in Great Britain is provided by the Town and Country Planning Act 1990 [44] and the Town and Country Planning (Scotland) Act 1972 [48], both of which have been amended by the Planning and Compensation Act 1991 [49].

The primary planning legislation in Northern Ireland is the Planning (Northern Ireland) Order 1991 [50]. Acts of Parliament, rules and orders which are of relevance include the Environment Act 1995 [51] and the Planning and Compulsory Purchase Act 2004 [45]. There is also separate legislation controlling pollution, waste and statutory nuisance, much of which is now contained in the Environmental Protection Act 1990 [10].

The relevant planning authorities are as follows:

- a) England: county councils, metropolitan borough councils, unitary authorities, the national park authorities and the broads authority, where appropriate;
- b) Wales: the unitary planning authorities and national park planning boards where appropriate;
- c) Scotland: the local authority;
- d) Northern Ireland: Department of the Environment for Northern Ireland.

In England, the Secretary of State for Communities and Local Government is responsible for setting out government policy on A_1 noise from mineral extraction and production, which is contained in the Technical Guidance to the National Planning Policy Framework [15] A_1 .

In Wales, general policy is supplemented by Welsh Office guidance. Policy guidance in Scotland is provided by the Scottish Office in National Planning Policy Guidelines (NPPGs) and circulars, and advice on best practice in Planning Advice Notes (PANs). NPPG 4 [53], PAN 50 [54] and the associated PAN 50 Annex A [16], are of particular relevance to this standard. The Secretary of State for Communities and Local Government in England, the Scottish Minister for Scotland, and the Minister for Environment, Planning and Countryside in Wales, all have powers as defined by the legislation in relation to the submission of planning applications, determination of appeals and in respect of development plans.

Most minerals in Britain are privately owned and are worked by commercial operating companies. Sometimes, however, ownership of the land is divorced from the rights to extract the mineral. Mineral extraction, as a form of development, requires planning permission in order to be undertaken; guidance on the procedures being contained within MPG 2 [55], MPG 8 [56] and MPG 9 [40]. The Mineral Planning Authorities (MPAs), or on appeal the Secretary of State, will consider and either approve or refuse mineral planning applications according to their decision as to the acceptability of the proposals. In the case of an appeal, a public inquiry might be held and the Inspector (Reporter in Scotland) might determine the appeal or make a recommendation to the Secretary of State. All planning permissions are subject to conditions controlling relevant aspects of the development, including noise and vibration.

A.4 Local authorities

The local authorities exercising powers under Part III of the Control of Pollution Act 1974 [9] and Part III of the Environmental Protection Act 1990 [10] are as follows:

- a) in England, the council of a district or a district or a London borough, the Common Council of the City of London, the Sub-Treasurer of the inner temple and the Under Treasurer of the Middle Temple;
- b) in Wales, the council of a county or a county borough;
- c) in Scotland, an islands or district council.

In Northern Ireland, district councils exercise similar functions under the Pollution Control and Local Government (Northern Ireland) Order 1978 [17].

The local authorities exercising planning powers are, according to the circumstances, in England, county councils or district councils, and in Scotland, the regional councils in the Borders, Highland, and Dumfries and Galloway Regions and district or islands councils elsewhere. In Northern Ireland, planning control is a function of the Department of the Environment (Northern Ireland).

For the winning and working of minerals, the relevant authority needs to be consulted as follows:

- England: county councils, metropolitan boroughs, unitary authorities and national park planning boards where appropriate;
- Wales: the unitary planning authorities and national park planning boards where appropriate;
- Scotland: unitary planning authorities;
- Northern Ireland: Department of the Environment for Northern Ireland.

In the case of uncertainty as to which local authority or local authority department to consult about a noise problem, a good starting point is often the environmental health department of the district or London borough council; in Scotland, the district or islands council; or in Northern Ireland, the Department of Environment (Northern Ireland) in Belfast.

Annex B (informative)

Noise sources, remedies and their effectiveness

B.1 The effectiveness of noise control at source

Examples of typical attenuations afforded to various noise sources by equipment modifications, the use of acoustic enclosures and sheds (see **B.2** and **B.3**) or the replacement of inherently noisy plant by less noisy alternatives are given in Table B.1.

The degree of attenuation achieved will vary from the typical value quoted depending on such parameters as source size, orientation and noise spectrum characteristics. Furthermore, the effectiveness of any given measure in controlling noise will depend very much on the prevailing circumstances. For example, noise from hammer-driven piling operations can be controlled to a limited extent by the use of the various methods described in Table B.1. However, the attenuations provided are not likely to alleviate totally any disturbance from such high intensity sources. Alternative methods of piling, where practicable, can provide more beneficial reductions in noise levels. Other simple noise control measures can provide useful reductions in overall site noise levels.

Table B.1 Methods of reducing noise levels from construction plant

Plant	Noise reduction of plant	Alternative plant
Hammer drive piling equipment	<p>Source of noise</p> <p>Pneumatic/diesel hammer or steam winch vibrator driver</p>	<p>Bored piling</p> <p>Vibratory system</p> <p>Drop hammer completely enclosed in box with opening at top for crane access</p> <p>Steel jacket completely enclosing drop hammer with dolly and polystyrene chips fed to impact surface to dissipate energy</p> <p>Pressed-in piling which generates its driving force from the frictional restraint of other piles</p>
	<p>Possible remedies (to be discussed with machine manufacturers)</p> <p>Enclose hammer head and top of pile in acoustic screen</p>	
	<p>A-weighted sound reduction</p> <p>5 to 10 dB</p>	
	<p>Sheet pile</p> <p>Acoustically dampen sheet steel piles to reduce levels of resonant vibration</p>	
	<p>Impact on pile</p> <p>Use resilient pad (dolly) between pile and hammer head. Packing needs to be kept in good condition</p>	
Earth-moving plant:	<p>Cranes cables, pile guides and attachments</p> <p>Careful alignment of pile and rig</p>	<p>Alternative super silenced plant might be available. Consult manufacturers for details</p>
	<p>Power units or base machine</p> <p>Fix more efficient sound reduction equipment or exhaust. Acoustically dampen panels and covers. When intended by the manufacturer, engine panels need to be kept closed. Use acoustic screens when possible</p>	
<ul style="list-style-type: none"> • bulldozer • compactor • crane • dump truck • dumper • excavator • grader • loader • scraper 	<p>Engine</p> <p>Fit more efficient exhaust sound reduction equipment</p> <p>Manufacturers' enclosure panels need to be kept closed</p>	<p>5 to 10</p>

Table B.1 Methods of reducing noise levels from construction plant (continued)

Plant	Noise reduction of plant		Alternative plant		
	Source of noise	Possible remedies (to be discussed with machine manufacturers)		A-weighted sound reduction dB	
Compressors and generators	Engine	Fit more efficient sound reduction equipment	Up to 10	Super silenced plant is available. Consult manufacturers for details	
	Compressor or generator body shell	Acoustically dampen metal casing			
	Total machine	Manufacturers' enclosure panels need to be kept closed			
Pneumatic concrete breaker, rock drills and tools	Total machine	Erect acoustic screen between compressor or generator and noise-sensitive area. When possible, line of sight between top of machine and reception point needs to be obscured	Up to 10	Sound-reduced compressor or generator can be used to supply several pieces of plant. Use centralized generator system	
		Enclose compressor or generator in ventilated acoustic enclosure			Up to 20
	Tool	Fit suitably designed muffler or sound reduction equipment to reduce noise without impairing machine efficiency	Up to 15		Hydraulic and electric tools are available
		Ensure all leaks in air line are sealed			
	Bit	Use dampened bit to eliminate ringing			For large areas of concrete, machine designed to break concrete in bending can be used
	Total machine	Erect acoustic screen between compressor or generator and noise-sensitive area. When possible, line of sight between top of machine and reception point needs to be obscured	Up to 10		Thermic lance
Enclose breaker or rock drill in portable or fixed acoustic enclosure with suitable ventilation		Up to 20			
Rotary drills, diamond drilling and boring	Drive motor and bit	Use machine inside acoustic shed with adequate ventilation	Up to 15	Thermic lance	

Table B.1 Methods of reducing noise levels from construction plant (continued)

Plant	Noise reduction of plant		Alternative plant
	Source of noise	Possible remedies (to be discussed with machine manufacturers)	
Riveters	Impact on rivet	Enclose work area in acoustic shed	Design for high tensile steel bolts instead of rivets
Pumps	Engine pulsing	Use machine inside acoustic enclosure with allowance for engine cooling and exhaust	Up to 20
Batching plant	Engine	Fit more efficient sound reduction equipment on diesel or petrol engines Enclose the engine	5 to 10
	Filling	Do not let aggregate fall from an excessive height	
Concrete mixers	Cleaning	Do not hammer the drum	
Materials handling	Impact of material	Do not drop materials from excessive heights. Screen dropping zones, especially on conveyor systems. Line chutes and dump trucks with a resilient material	Up to 15

B.2 Machinery enclosure design

The principles governing the design of covers for machinery are simple: for example, covers need to enclose machines as fully as possible (at least the noisy part), they need to possess adequate insulation so that noise energy does not readily pass through them, and they need to be lined inside with an efficient sound absorbent so that noise is not built up within them or reflected out through openings. Because a certain number of openings are nearly always necessary, either for access or for ventilation, it is usually sufficient if the insulation value of the structure forming a cover is about 25 dB; a sheet material mass of 10 kg/m² is expected to give this insulation. See Table B.2 for a list of materials.

Table B.2 Sound insulation characteristics of common building materials

Material	Thickness	Surface mass	Mean sound reduction index (100 Hz to 3 150 Hz)
	mm	kg/m ²	dB
Fibre cement boards	6	12	26
Brickwork	113	220	35 to 40
Chipboard	18	12	26
Clinker blocks	75	100	23
Fibreboard (insulation board)	12	4	18
Compressed straw	50	17	28
Plasterboard	13	12	26
Plywood	9	4.5	24
Woodwool/cement slabs 50 mm thick, each face with 13 mm thick plaster	76	70	35

The effective insulation value allowing for openings is unlikely to be more than 20 dB, but this is a useful reduction of machinery noise. If a machine produces predominantly low-frequency noise, a heavier cover than that suggested needs to be provided.

The sound-absorbent lining inside covers normally need to be at least 25 mm thick, unless the noise is almost entirely high frequency when 12 mm thickness might be sufficient. Useful inexpensive materials for the purpose are mineral wool or woodwool, though proprietary absorbent tiles, etc., can be used if preferred. See Table B.3 for a list of materials. Mineral wool needs to be contained behind some sort of perforated facing, which can take the form of wire netting, expanded metal perforated sheet or perforated boards, etc. The degree of perforation normally needs to be not less than 10%. The usual method of construction for machinery covers is timber or metal framing with an absorbent material placed between the frame members, an external insulating cover and an internal protective mesh or perforated lining. The possible existence of a fire hazard has to be borne in mind, whatever absorbent material is chosen; particularly if the absorbent material can become contaminated with oil.

The enclosure of compressors, generators, etc., can pose cooling and ventilation problems. Such problems can sometimes be solved by using the radiator cooling fan to induce a flow of air through the enclosure as a whole by placing a baffle in the plane of the radiator, as shown in Figure B.1. It is advisable to obtain advice from

the manufacturer (of the machinery to be enclosed), to ensure that adequate ventilation is provided by the enclosure and that there is sufficient access for maintenance.

Table B.3 Sound-absorbing materials for lining covers and enclosures

Material	Thickness mm	Average absorption coefficient between 125 Hz and 4 000 Hz
Mineral wool	50	0.7 to 0.8
Straw slabs	50	0.4
Woodwool slabs	50	0.6

Figure B.1 Example of machine enclosure

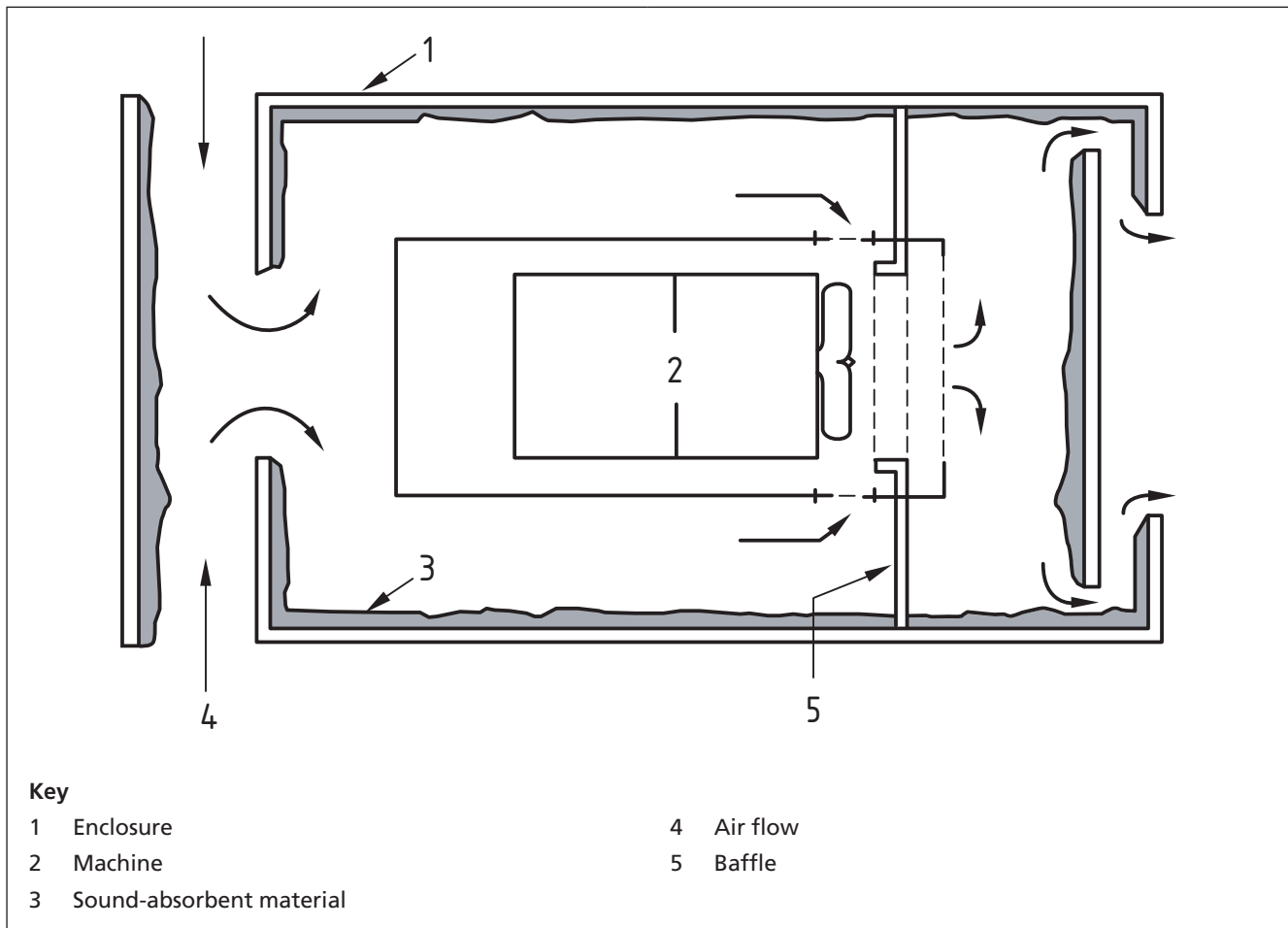

B.3 Acoustic shed design

Effective screening depends on the extent to which the noise source can be enclosed without the operation of the equipment being adversely affected or the operator being exposed to additional occupational health and safety hazards such as:

- a) increased noise levels inside through reflection;
- b) excessive heat;
- c) increased dust exposure;

- d) exacerbated effects of flash-over in the event of an electric cable strike occurring;
- e) increased risk of dangerous accumulations of gas from a leak;
- f) poor lighting.

Acoustic sheds can also be a traffic hazard, especially during erection and dismantling.

An acoustic shed designed by the Building Research Establishment is shown in Figure B.2. Performance characteristics are given in Table B.4 for the types of enclosure illustrated in Figure B.3.

Figure B.2 Typical acoustic shed

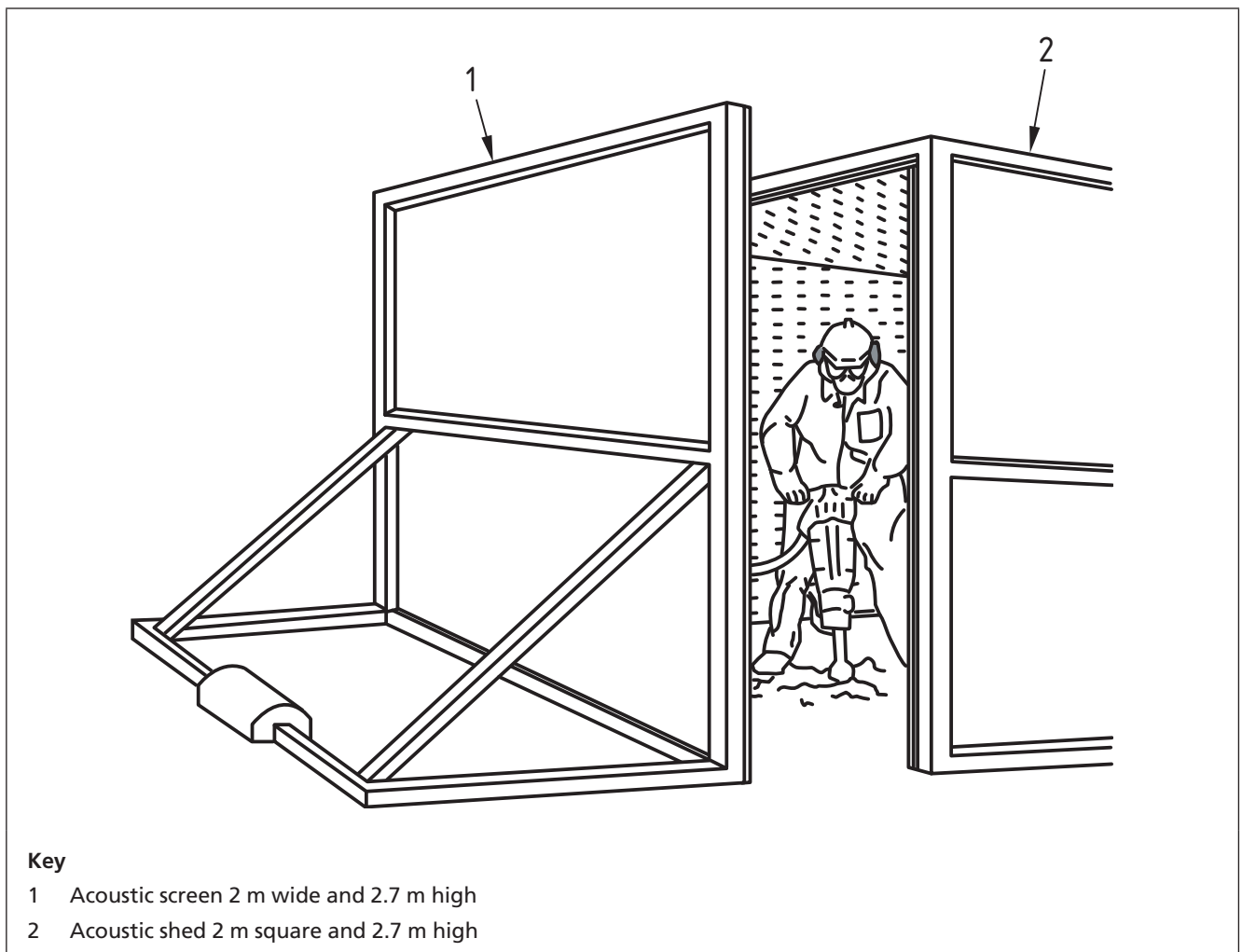
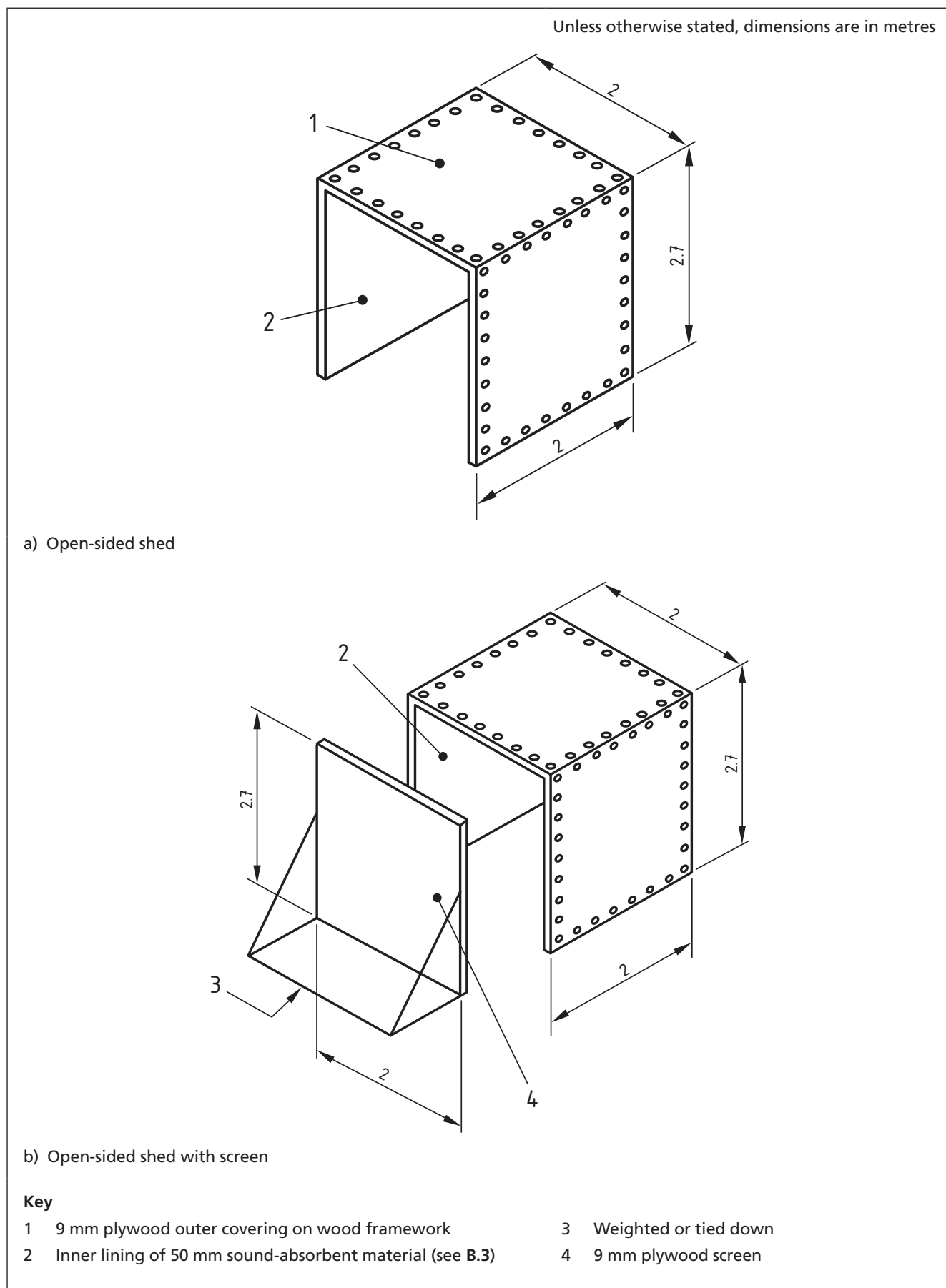

Table B.4 Measured sound reduction given by types of partial enclosure

Type of enclosure (see Figure B.3)	Reduction dB(A)		
	Facing the opening(s)	Sideways	Facing rear of shed
Open-sided shed lined with absorbent material; no screen	1	9	14
Open-sided shed lined with absorbent material; with reflecting screen in front	10	6	8
Open-sided shed lined with absorbent material; with absorbent screen in front	10	10	10

Figure B.3 Examples of acoustic open-sided sheds



An acoustic shed can be made of 9 mm plywood or other solid material weighing about 5 kg/m², on simple timber framing, with no gaps at joints or corners. There is no worthwhile advantage in using a heavier construction for portable sheds. The inside is typically lined with 50 mm of sound-absorbent material, or with 25 mm of similar material if mounted on battens. Such linings are not expected to constitute a fire hazard. Mineral wool blankets used as sound-absorbent material will usually need to be protected by wire mesh or perforated sheets. Sheet coverings typically have at least 10% of their surface area perforated, with the distance between perforations not exceeding 13 mm. The lining prevents a build-up of noise inside the enclosure and improves conditions for the operator. It does not reduce the noise transmitted through the screen or shed. Gaps between the sides and the ground are typically closed with a flap of a special tough grade of polyethylene sheeting or other similar flexible material. An extractor fan might be required to prevent a build-up of dust. Artificial lighting might also be necessary.

For more permanent enclosures, blockwork is a useful form of construction.

Open-textured lightweight aggregate blocks provide a useful degree of sound absorption and breeze blocks, which can be used for robust enclosures, are durable, relatively inexpensive and quick to assemble, and their rough surface texture provides a degree of sound absorption. Joints need to be properly made.

B.4 Acoustic screens

Care is needed in the design, siting and construction of a barrier for screening purposes if it is to be effective. A barrier can, by reflecting sound, simply transfer a problem from one receiving position to another. On level sites, for maximum effectiveness, a barrier needs to be brought as close as possible to either the noise source or the receiving positions, with no gaps or openings at joints in the barrier material.

In design it might be necessary for sound transmitted both through and around the barrier to be considered. However, in most practical situations the overall attenuation will be limited by transmission over and around the barrier, provided that the barrier material has a mass per unit of surface area in excess of about 7 kg/m² and there are no gaps at the joints. When equipment is to be screened for many months, sand bags can be useful as they are durable, easy to erect and easy to remove. Ordinary building materials normally stored on site (e.g. bricks, aggregate, timber or top soil) can, if carefully sited, provide noise screening without additional cost. Woodwool slabs are also effective when fixed to posts. Plywood sheets can be fixed to a scaffold support frame and, if constructed in sections, can provide a portable barrier.

Some sound will pass round the ends of short straight barriers. As a rough guide, the length of a barrier is typically at least five times greater than its height. A shorter barrier is bent round the noise source. The minimum height of barriers are typically such that no part of the noise source will be visible from the receiving point.

Annex C (informative) Current sound level data on site equipment and site activities

C.1 General

NOTE The information given in Tables C.1 to C.11 is reproduced by permission of the Department for Environment, Food and Rural Affairs (Defra). The levels recorded represent individual measurements on specific items of plant.

The data listed in Tables C.1 to C.11 are taken from tables published by Defra in 2005. They are supplemented by Table C.12, which contains additional, recently acquired, information on piling and ancillary operations, supplied by the Federation of Piling Specialists and the Steel Piling Group. Table C.12, unlike Tables C.1 to C.11 inclusive, does not include octave band information.

Historic data tables taken from the 1997 edition of BS 5228-1 and the 1992 edition of BS 5228-4 are included in Annex D. The tables in Annex D are intended for use only when no appropriate data exists in the tables in Annex C.

C.2 Presentation of data

The lists of site equipment and activities given in Tables C.1 to C.12 do not cover the complete range of equipment used or all the activities undertaken during the various stages of site work. Users of this part of BS 5228 need to be aware of the processes involved in the development of a site and of the equipment that can be used. When necessary, the tables can be extended to include additional information concerning site equipment and activities, and their sound levels, for future reference.

Values of the sound power levels for a particular type and size of machine and the equivalent continuous sound pressure levels for the site activities given in Tables C.1 to C.12 will apply in the majority of cases, but can be lower or higher due to the make and maintenance of the machines, their operation and the procedures adopted when work is carried out.

An estimate can be made of site noise by averaging the sound levels of equipment of similar type and size, and of site activities as discussed in Annex F.

In Tables C.1 to C.11 inclusive, the broad band data relate to the activity $L_{Aeq,T}^{(A)}$ at a standard distance of 10 m, except for entries marked with an asterisk *, which show the L_{Amax} measured during drive by of mobile plant at a distance of 10 m. Except where otherwise shown, e.g. in Table C.12, the $L_{WA,r}$ which is to be used in certain of the prediction procedures described in Annex F, may be obtained by adding 28 dB(A) to the broad band $L_{Aeq,T}^{(A)}$ or L_{Amax} as appropriate (for further details, refer to Annex D, D.1, paragraph 3).

Table C.1 Sound level data on demolition

Ref no.	Equipment	Power rating, kW	Equipment size, weight (mass), capacity	Octave band sound pressure levels at 10 m, Hz							A-weighted sound pressure level, $L_{Aeq,T}(\Delta)$ dB at 10 m
				63	125	250	500	1k	2k	4k	
Breaking up concrete											
1	Breaker mounted on wheeled backhoe	59	(7.4 t) 380 kg / 1 700 mm tool / 74 mm dia. / 125 bar	79	82	81	82	86	86	85	92
2	Breaker mounted on wheeled backhoe	—	380 kg / 1 700 mm tool / 74 mm dia. / 125 bar	79	84	82	84	88	85	84	92
3	Pulverizer mounted on excavator	—	—	85	76	74	75	74	75	70	80
4	Pulverizer mounted on excavator	147	30 t	75	72	71	73	70	69	66	76
5	Pulverizer mounted on excavator	143	29 t	73	73	69	70	67	64	58	72
6	Hand-held pneumatic breaker	—	—	83	83	81	74	73	76	78	83
7	Hand-held hydraulic breaker	—	20 kg / 69 bar	82	81	87	87	88	86	83	93
8	Hydraulic breaker power pack	6	63 kg / 138 bar	77	72	73	69	68	66	64	74
Breaking up brick foundations											
9	Breaker mounted on excavator	121	(15 t) 1 650 kg breaker	88	88	86	89	83	83	80	90
Dumping brick rubble											
10	Tracked excavator (loading dump truck)	228	44 t	82	78	82	81	81	78	72	85
11	Articulated dump truck (dumping rubble)	250	28 t	94	76	77	75	76	73	68	80
Breaking and spreading rubble											
12	Tracked excavator	228	44 t	79	81	83	79	77	75	70	82
13	Tracked excavator	205	40 t	81	80	80	83	82	79	76	86
Crushing concrete/rubble											
14	Tracked crusher	172	47 t	93	86	79	81	75	71	66	82
15	Tracked crusher	—	—	86	84	84	81	78	75	71	84
Breaking up/cutting steel											
16	Tracked excavator	205	40 t	75	74	77	80	78	74	67	82
17	Tracked excavator	74	14 t	79	77	76	77	78	78	73	83
18	Gas cutter	—	—	72	72	69	72	73	72	71	79
Breaking stud partition											
19	Lump hammer	—	—	66	66	68	68	63	57	55	69
Breaking windows											
20	Lump hammer	—	—	77	75	71	72	74	74	75	81

Table C.2 Sound level data on site preparation

Ref no.	Equipment	Power rating, kW	Equipment size, weight (mass), capacity	Octave band sound pressure levels at 10 m, Hz								A-weighted sound pressure level, $L_{Aeq,T}(\Delta)$ dB at 10 m	
				63	125	250	500	1k	2k	4k	8k		
Clearing site													
1	Dozer *	142	20 t	79	77	76	74	68	67	60	59	75	*
2	Tracked excavator	301	71 t	75	84	78	74	70	68	64	61	77	
3	Tracked excavator	102	22 t	80	83	76	73	72	70	69	66	78	
4	Tracked excavator (idling)	102	22 t	59	49	45	45	49	46	39	31	52	
5	Tracked excavator	72	16 t	78	70	72	68	67	66	73	65	76	
6	Tracked excavator (idling)	72	16 t	64	62	64	62	56	53	47	39	63	
7	Tracked excavator	69	14 t	74	70	68	67	64	62	58	50	70	
8	Wheeled backhoe loader	62	8 t	74	66	64	64	63	60	59	50	68	
9	Wheeled backhoe loader (idling)	62	8 t	60	53	49	52	51	48	43	33	55	
Ground excavation/earthworks													
10	Dozer	239	41 t	89	90	81	73	74	70	68	64	80	
11	Dozer	179	28 t	75	79	77	77	74	71	65	57	79	
12	Dozer	142	20 t	85	74	76	73	72	78	62	56	81	
13	Dozer	82	11 t	74	83	78	74	74	70	67	62	78	
14	Tracked excavator	226	40 t	85	78	77	77	73	71	68	63	79	
15	Tracked excavator	173	32 t	77	85	70	73	70	68	63	57	76	
16	Tracked excavator	170	30 t	72	71	74	73	69	66	63	58	75	
17	Tracked excavator	162	28 t	78	78	75	71	72	68	63	55	76	
18	Tracked excavator	134	27 t	81	77	74	70	70	66	60	56	75	
19	Tracked excavator	125	25 t	95	84	79	73	70	68	64	57	77	
20	Tracked excavator (idling)	125	25 t	80	76	65	65	63	58	53	49	68	
21	Tracked excavator	107	22 t	75	76	72	68	65	63	57	49	71	
22	Tracked excavator	96	—	78	74	68	68	67	66	61	53	72	
23	Tracked excavator	92	—	79	81	68	69	66	65	61	52	73	
24	Tracked excavator	71	15 t	77	74	71	70	68	66	60	54	73	
25	Tracked excavator	66	14 t	77	65	67	67	63	61	57	47	69	

Licensed copy: WARRINGTON BOROUGH COUNCIL, 24/08/2018, Uncontrolled Copy, © BSI

Table C.2 Sound level data on site preparation (continued)

Ref no.	Equipment	Power rating, kW	Equipment size, weight (mass), capacity	Octave band sound pressure levels at 10 m, Hz							A-weighted sound pressure level, $L_{Aeq,T}$ dB at 10 m	
				63	125	250	500	1k	2k	4k		8k
Loading lorries												
26	Wheeled loader	209	—	87	82	77	78	73	70	64	57	79
27	Wheeled loader	193	—	85	83	76	75	75	72	72	61	80
28	Wheeled loader	170	—	86	82	77	74	70	66	62	55	76
29	Tracked excavator	75	15 t	80	79	76	77	73	70	66	59	79
Distribution of material												
30	Dump truck (tipping fill)	306	29 t	85	74	78	73	73	74	67	63	79
31	Dump truck (empty) *	306	29 t	86	79	79	79	79	84	69	60	87
32	Articulated dump truck (tipping fill)	187	23 t	80	76	73	70	69	66	63	58	74
33	Articulated dump truck *	187	23 t	85	87	77	75	76	73	69	62	81
34	Lorry *	—	4-axle wagon	73	78	78	78	74	73	68	66	80
35	Telescopic handler	60	10 t	85	79	69	67	64	62	56	47	71
Rolling and compaction												
36	Dozer (towing roller)	142	20 t	83	77	77	76	76	75	68	56	81
37	Roller (rolling fill) *	145	18 t	72	75	81	78	74	70	63	55	79
38	Roller *	145	18 t	80	75	77	72	67	62	54	46	73
39	Vibratory roller *	29	4 t	88	83	69	68	67	65	62	59	74
40	Vibratory roller *	20	3 t	82	78	67	71	67	64	60	57	73
41	Vibratory plate (petrol)	3	62 kg	70	74	71	78	74	75	63	58	80
42	Hydraulic vibratory compactor (tracked excavator)	—	225 kg / 193 bar / 17 500 N	81	76	72	73	72	72	68	63	78
Ground investigation drilling												
43	Cable percussion drilling rig	18	2 t / 150 mm diameter / 75 m depth	77	77	67	66	70	68	62	56	74
Directional drilling												
44	Directional drill (generator)	106	—	67	80	74	72	72	72	68	61	77
Pumping water												
45	Water pump	20	6 in	73	68	62	62	61	56	53	41	65
46	Water pump	—	4 in	75	74	60	54	54	53	48	46	62

* Drive-by maximum sound pressure level in $L_{r,max}$ (octave bands) and $L_{A,max}$ (overall level)

Table C.3 Sound level data on piling and ancillary operations

Ref no.	Equipment	Power rating, kW	Equipment size, weight (mass), capacity	Octave band sound pressure levels at 10 m, Hz							A-weighted sound pressure level, $L_{Aeq,T}$ dB at 10 m	
				63	125	250	500	1k	2k	4k		8k
Pre-cast concrete piling – hydraulic hammer												
1	Hydraulic hammer rig	145	16 m length / 5 t hammer / plywood dolly	82	82	82	89	83	78	75	70	89
Tubular steel piling – hydraulic hammer												
2	Hydraulic hammer rig	186	4 t hammer	80	87	88	84	83	78	74	65	87
3	Hydraulic hammer rig	—	240 mm diameter	87	93	85	87	83	80	75	72	88
4	Hydraulic hammer rig	—	(1 t) 2 m length / 300 mm diameter	73	65	65	64	70	72	72	68	77
5	Drop hammer pile rig power pack	23	—	79	65	60	59	66	63	53	46	69
Tubular steel piling – hydraulic jacking												
6	Piling	2 800 kN	10 t / 13 m length / 900 mm width / soil	80	74	70	65	61	57	49	43	68
7	Power pack	147	6 t	77	78	73	66	63	57	50	42	70
Sheet steel piling – vibratory												
8	Vibratory piling rig	—	52 t / 14 m length / soft clay	83	82	79	82	84	82	77	67	88
Sheet steel piling – hydraulic jacking												
9	Piling	1 500 kN	10 t / 7.4 m length / 600 mm width / sandy clay	74	71	63	60	56	54	50	44	63
10	Power pack	147	6 t	80	75	69	67	61	55	49	43	68
11	Piling	980 kN	7.4 t / 12 m length / 500 mm width	68	60	59	57	51	50	45	44	59
12	Rig power pack	—	5 t	74	70	66	60	54	51	46	42	63
13	Water jet pump	—	—	75	75	62	58	55	54	48	40	63
Rotary bored piling – cast in situ												
14	Large rotary bored piling rig	—	110 t / 20 m deep / 1.2 m diameter	84	92	81	80	78	76	68	61	83
15	Tracked drilling rig with hydraulic drifter	104	12.5 t	75	79	76	73	74	79	74	69	82
16	Crane mounted auger	—	—	87	86	77	73	75	72	67	59	79
17	Mini piling rig	29	5.4 t / auger 10 m deep x 450 mm diameter piles	87	77	72	73	71	69	65	57	76
18	Mini piling rig	—	Auger 12 m deep x 250 mm diameter piles	74	72	65	71	70	68	63	57	75
19	Compressor for mini piling	45	1 t	75	71	65	70	71	69	62	57	75
20	Mini tracked excavator	17	2.8 t	76	73	62	66	62	59	54	49	68

Table C.3 Sound level data on piling and ancillary operations (continued)

Ref no.	Equipment	Power rating, kW	Equipment size, weight (mass), capacity	Octave band sound pressure levels at 10 m, Hz							A-weighted sound pressure level, $L_{Aeq,T}$ dB at 10 m	
				63	125	250	500	1k	2k	4k		8k
Continuous flight auger piling – cast in situ												
21	Crawler mounted rig	150	35 t	81	81	78	76	74	72	68	63	79
22	Crawler mounted rig	126	33 t	79	79	78	78	75	71	66	56	80
23	Tracked excavator	—	—	84	76	67	64	62	59	53	43	68
24	Tracked excavator (inserting cylindrical metal cage)	—	20 t	79	75	73	69	69	67	60	52	74
25	Concrete pump	59	2.8 t / 180 mm diameter / 59 bar	84	76	70	71	73	73	66	58	78
26	Concrete pump	25	120 mm diameter / 50 bar	82	82	72	71	69	68	62	54	75
Vibro stone columns												
27	Vibrodisplacement and compaction of stone columns	60	17 t	91	84	79	77	74	69	70	59	80
Craneage for piling (lifting piles, casings, etc)												
28	Tracked mobile crane	184	110 t	81	77	66	62	59	57	51	46	67
29	Tracked mobile crane	132	55 t	81	77	69	67	62	60	61	51	70
30	Wheeled mobile crane	—	70 t	80	72	71	67	65	62	57	49	70
Welding / cutting steel piles												
31	Hand-held welder (welding piles)	—	—	67	68	69	68	69	66	61	56	73
32	Generator for welding	—	—	75	72	67	68	70	66	62	60	73
33	Generator for welding	6	508 kg	75	67	59	52	48	44	41	33	57
34	Gas cutter (cutting top of pile)	—	230 bar	74	74	72	61	60	58	56	56	68
35	Hand-held gas cutter	—	230 bar	74	76	66	58	56	56	55	55	65

Table C.4 Sound level data on general site activities

Ref no.	Equipment	Power rating, kW	Equipment size, weight (mass), capacity	Octave band sound pressure levels at 10 m, Hz								A-weighted sound pressure level, $L_{Aeq,T}$ dB at 10 m	
				63	125	250	500	1k	2k	4k	8k		
Distribution of materials													
1	Articulated dump truck *	194	25 t	90	87	77	79	75	73	67	63	81	*
2	Articulated dump truck *	187	23 t	85	80	77	72	74	70	65	58	78	*
3	Dumper *	81	7 t	84	81	74	73	72	68	61	53	76	*
4	Dumper *	75	9 t	82	76	75	74	68	68	64	55	76	*
5	Dumper (idling)	75	9 t	73	64	55	55	60	56	50	43	63	
6	Dumper *	60	6 t	89	86	77	74	72	72	66	62	79	*
7	Dumper *	56	5 t	90	86	72	71	71	71	66	59	78	*
8	Dumper (idling)	56	5 t	68	56	47	49	52	50	41	32	56	
9	Dumper *	32	3 t	82	82	78	77	69	67	61	53	77	*
10	Wheeled excavator	90	18 t	64	60	63	64	62	57	51	45	66	
11	Wheeled excavator (idling)	90	18 t	61	59	57	57	58	52	42	34	61	
12	Wheeled excavator *	63	14 t	84	82	77	75	72	68	60	52	77	*
13	Wheeled loader *	75	37 t	83	72	70	69	65	64	57	49	71	*
14	Wheeled backhoe loader	62	9 t	68	67	63	62	62	61	54	47	67	
15	Fuel tanker lorry *	—	11 t	79	73	71	75	72	67	59	50	76	*
16	Fuel tanker pumping	—	25000 L	75	70	67	67	69	66	60	53	72	
17	Tracked excavator	41	8 t	81	72	68	68	66	64	60	55	71	
Mixing concrete													
18	Cement mixer truck (discharging)	—	—	80	69	66	70	71	69	64	58	75	
19	Cement mixer truck (idling)	—	—	77	71	65	65	66	66	60	51	71	
20	Concrete mixer truck	—	—	83	74	66	69	70	78	60	55	80	
21	Large lorry concrete mixer	216	—	80	71	65	72	71	72	68	56	77	
22	Large concrete mixer	167	26 t	72	73	79	72	69	67	63	60	76	
23	Small cement mixer	2	—	61	65	58	58	57	53	51	49	61	

Table C.4 Sound level data on general site activities (continued)

Ref no.	Equipment	Power rating, kW	Equipment size, weight (mass), capacity	Octave band sound pressure levels at 10 m, Hz								A-weighted sound pressure level, $L_{Aeq,T}(\Delta)$ dB at 10 m
				63	125	250	500	1k	2k	4k	8k	
Pumping concrete												
24	Concrete pump + cement mixer truck (discharging)	223	8 t / 350 bar	69	64	64	66	63	59	53	47	67
25	Concrete pump + concrete mixer truck (pumping to 5th floor)	171	6 t / 350 bar / 150 mm diameter	83	81	78	79	77	74	71	66	82
26	Concrete pump + concrete mixer truck (idling)	171	6 t / 350 bar / 150 mm diameter	75	76	71	70	71	68	64	60	75
27	Concrete mixer truck	—	—	84	74	74	73	73	75	65	59	79
28	Concrete mixer truck (discharging) & concrete pump (pumping)	—	26 t (capacity) / 7 m ³ + 22 m boom	79	80	73	72	69	68	59	53	75
29	Truck mounted concrete pump + boom arm	—	26 t	83	77	75	75	74	75	67	63	80
30	Truck mounted concrete pump + boom arm	—	17 t	71	76	71	76	76	72	66	62	79
31	Truck mounted concrete pump + boom arm (idling)	—	22 m boom	84	75	71	70	70	69	61	52	75
32	Concrete mixer truck + truck mounted concrete pump + boom arm	—	—	73	73	77	76	72	70	65	62	78
Concreting other												
33	Poker vibrator	—	—	82	80	80	73	69	72	70	65	78
34	Poker vibrator	2.2	—	62	70	70	64	62	61	59	56	69
35	Vibratory tamper	1.1	15 kg	59	71	54	56	57	55	55	49	63
36	Pump boom + vibrating poker	—	—	71	68	68	67	65	64	59	56	71
37	Concrete placing boom	—	142 mm diameter / 24 m reach	63	68	65	62	59	53	53	49	65

Table C.4 Sound level data on general site activities (continued)

Ref no.	Equipment	Power rating, kW	Equipment size, weight (mass), capacity	Octave band sound pressure levels at 10 m, Hz								A-weighted sound pressure level, $L_{Aeq,T}$ dB at 10 m	
				63	125	250	500	1k	2k	4k	8k		
Lifting													
38	Wheeled mobile telescopic crane	610	400 t	80	79	73	74	73	73	73	64	55	78
39	Mobile telescopic crane	315	80 t	87	82	78	74	71	67	60	52	52	77
40	Mobile telescopic crane (idling)	315	80 t	75	72	65	62	61	60	52	45	45	66
41	Mobile telescopic crane	280	100 t	73	71	68	70	66	63	54	49	41	71
42	Mobile telescopic crane (idling)	280	100 t	71	67	64	61	60	56	50	41	41	64
43	Wheeled mobile crane	275	35 t	80	76	71	63	64	63	56	50	50	70
44	Wheeled mobile crane (idling)	275	35 t	73	66	55	56	56	53	45	36	36	60
45	Mobile telescopic crane	260	55 t	90	81	78	74	77	76	69	61	61	82
46	Mobile telescopic crane	240	50 t	78	69	67	64	62	57	49	40	40	67
47	Mobile telescopic crane (idling)	240	50 t	67	66	59	58	56	53	44	35	35	61
48	Tower crane	88	22 t	82	77	80	76	66	66	56	50	50	76
49	Tower crane	51	12 t	84	79	80	76	70	63	57	51	51	77
50	Tracked mobile crane	390	600 t / 125 m	68	71	68	62	66	66	55	46	46	71
51	Tracked mobile crane (idling)	390	600 t / 125 m	66	67	60	61	62	61	50	40	40	66
52	Tracked mobile crane	240	105 t	73	71	66	67	74	66	58	49	49	75
53	Lorry with lifting boom	50	6 t	81	78	76	74	72	69	64	56	56	77
54	Telescopic handler	76	4 t	79	73	66	65	78	66	54	47	47	79
55	Telescopic handler	75	3.7 t	82	72	63	65	67	64	56	49	49	70
56	Wheeled excavator	63	14 t	87	84	80	81	78	75	69	67	67	83
57	Lifting platform	35	8 t	78	76	62	63	60	59	58	49	49	67
58	Lifting platform (idling)	35	8 t	72	71	59	59	56	56	52	45	45	63
59	Diesel scissor lift	24	6 t	80	77	74	74	74	71	65	63	63	78
60	Diesel scissor lift (idling)	24	6 t	74	72	68	68	64	61	57	56	56	70
61	Caged material hoist (electric)	—	500 kg	64	64	65	65	63	61	59	52	52	68
62	Site lift for workers	—	—	68	63	64	63	59	60	58	51	51	66

Table C.4 Sound level data on general site activities (continued)

Ref no.	Equipment	Power rating, kW	Equipment size, weight (mass), capacity	Octave band sound pressure levels at 10 m, Hz							A-weighted sound pressure level, $L_{Aeq,T}$ dB at 10 m	
				63	125	250	500	1k	2k	4k		8k
Trenching												
63	Tracked excavator	223	40 t	77	86	75	75	71	69	64	55	77
64	Tracked excavator	107	22 t	74	80	75	73	69	66	60	51	75
65	Tracked excavator	95	21 t	76	74	68	70	65	63	59	55	71
66	Wheeled backhoe loader	63	8 t	72	63	67	67	63	62	56	50	69
67	Mini tracked excavator	—	5 t	87	79	76	70	68	64	57	48	74
68	Mini tracked excavator	30	5 t	71	71	66	59	59	58	54	48	65
Core drilling concrete												
69	Core drill (electric)	—	250 mm diameter bit	75	74	75	72	74	75	80	80	85
Cutting concrete floor slab												
70	Petrol hand-held circular saw	3	9 kg / 300 mm diameter	72	89	81	80	80	82	86	85	91
Cutting concrete blocks / paving slabs												
71	Circular bench saw (petrol-cutting concrete blocks)	—	—	85	74	72	70	72	76	82	77	85
72	Hand-held circular saw (petrol-cutting concrete blocks)	3	9 kg	69	75	77	74	71	70	74	69	79
73	Hand-held circular saw (cutting paving slabs)	1.5	7.6 kg / 235 mm diameter	73	67	70	68	73	78	78	77	84
Moving equipment												
74	Tractor (towing equipment) *	100	—	79	71	78	75	78	70	61	55	80
75	Tractor (towing trailer) *	71	3.5 t	93	86	76	76	73	72	64	59	79
Power for site cabins												
76	Diesel generator	6.5	—	80	74	57	54	53	48	45	37	61
77	Diesel generator	—	—	70	62	62	57	53	52	48	41	60
78	Diesel generator	—	—	64	67	68	65	58	54	49	42	66
79	Diesel generator	—	—	69	71	68	61	57	51	46	44	64
80	Diesel generator	—	—	54	64	59	56	55	52	49	45	60
81	Petrol generator	—	2 t	63	57	58	53	51	46	38	33	56
82	Diesel generator	—	2 t	64	61	59	53	49	47	42	35	56
83	Diesel generator	3	210 kg	57	71	65	61	60	56	52	44	65
84	Diesel generator	—	—	75	72	76	70	69	65	56	47	74

Table C.4 Sound level data on general site activities (continued)

Ref no.	Equipment	Power rating, kW	Equipment size, weight (mass), capacity	Octave band sound pressure levels at 10 m, Hz								A-weighted sound pressure level, $L_{Aeq,T}$ dB at 10 m
				63	125	250	500	1k	2k	4k	8k	
Power for welder												
85	Diesel generator	4	18 kg	69	69	67	60	59	60	56	53	66
Power for lighting												
86	Diesel generator	15	—	78	71	66	62	59	55	56	49	65
87	Diesel generator	7.5	6 kVA / 3 000 rpm	77	72	64	60	59	57	54	42	65
Pumping water												
88	Water pump (diesel)	10	100 kg	70	65	66	64	64	63	56	46	68
89	Water tanker extracting water (vacuum pump)	—	—	81	82	67	72	71	74	73	66	79
Sweeping and dust suppression												
90	Road sweeper	70	—	80	75	69	75	71	67	61	58	76
91	Dust suppression unit trailer	—	—	78	73	74	80	70	68	60	56	78
Miscellaneous												
92	Mounting supports for directional drill (hydraulic hammer)	—	—	77	83	73	68	73	80	84	77	87
93	Angle grinder (grinding steel)	2.3	4.7 kg	57	51	52	60	70	77	73	73	80
94	Petrol generator for hand-held grinder	3.75	105 kg	77	74	71	70	69	68	66	62	75
95	Handheld cordless nail gun	—	15 to 50 mm nails	63	65	65	66	65	69	64	61	73
96	Directional drill (generator)	106	—	67	80	74	72	72	72	68	61	77

* Drive-by maximum sound pressure level in $L_{r,max}$ (octave bands) and $L_{A,max}$ (overall level)

Table C.5 Sound level data on road construction works

Ref no.	Equipment	Power rating, kW	Equipment size, weight (mass), capacity	Octave band sound pressure levels at 10 m, Hz								A-weighted sound pressure level, $L_{A,eq,T}(\Delta)$ dB at 10 m
				63	125	250	500	1k	2k	4k	8k	
Breaking road surface												
1	Backhoe mounted hydraulic breaker	67	—	86	80	78	77	81	83	82	81	88
2	Mini excavator with hydraulic breaker	—	(1.5 t) 44 mm diameter / 115 bar / 120 kg	79	75	73	74	77	77	75	70	83
3	Road breaker (hand-held pneumatic)	—	—	82	75	73	68	63	67	80	69	82
4	Road breaker (hand-held pneumatic)	—	—	84	84	74	75	73	77	83	81	86
5	Compressor for hand-held pneumatic breaker	—	1 t	84	73	64	59	57	55	58	47	65
Breaking concrete												
6	Hand-held pneumatic breaker	—	—	90	79	75	78	78	83	91	92	95
Road planing												
7	Road planer	185	17 t	81	87	79	77	77	74	70	67	82
8	Road planer (idling)	185	17 t	67	59	58	60	59	49	46	38	62
9	Mini planer	32	3 t	72	67	70	65	62	56	53	48	68
10	Mini planer (idling)	32	3 t	67	53	58	50	47	45	42	39	54
Removing broken road surface												
11	Wheeled excavator	112	17 t	78	74	68	71	68	64	59	52	73
Spreading chipping/fill												
12	Dozer	104	14 t	80	78	71	70	74	68	65	61	77
13	Dozer	68	11 t	82	84	76	75	78	76	70	62	82
Earthworks												
14	Bulldozer *	250	35 t	77	86	75	75	82	80	73	67	86
15	Bulldozer *	134	24 t	83	81	76	77	82	70	65	58	83
16	Articulated dump truck *	194	25 t	88	90	80	79	76	71	65	61	81
17	Articulated dump truck *	187	23 t	85	88	77	75	77	74	69	63	81
18	Tracked excavator	172	35 t	76	79	75	75	76	73	70	65	80

Table C.5 Sound level data on road construction works (continued)

Ref no.	Equipment	Power rating, kW	Equipment size, weight (mass), capacity	Octave band sound pressure levels at 10 m, Hz								A-weighted sound pressure level, $L_{Aeq,T}$ dB at 10 m	
				63	125	250	500	1k	2k	4k	8k		
Rolling and compaction													
19	Road roller *	95	22 t	87	85	75	73	75	73	69	63	80	*
20	Vibratory roller	98	8.9 t	90	82	73	72	70	65	59	54	75	
21	Vibratory roller *	95	12 t	90	84	77	81	73	68	65	61	80	*
22	Vibratory roller *	92	12 t	92	83	75	79	77	70	67	61	81	*
23	Vibratory roller (not vibrating) *	—	12 t	83	77	75	84	76	72	66	61	83	*
24	Vibratory roller *	53	12 t	89	82	76	77	72	74	81	61	84	*
25	Vibratory roller	32	4.5 t	80	75	72	75	69	66	62	57	75	
26	Vibratory roller	—	4 t	84	84	78	70	70	70	67	61	77	
27	Vibratory roller	20	3 t	85	70	62	62	61	59	53	45	67	
28	Vibratory roller	12	1.5 t	82	80	76	73	70	70	63	59	77	
29	Vibratory compacter (asphalt)	3	60 kg	76	78	74	77	77	77	73	70	82	
Paving													
30	Asphalt paver (+ tipper lorry)	112	12 t hopper	78	77	72	72	71	69	62	56	75	
31	Asphalt paver (+ tipper lorry)	94	18 t	72	77	74	72	71	70	67	60	77	
32	Asphalt paver (+ tipper lorry) *	94	18 t	87	84	81	80	79	76	74	65	84	*
33	Asphalt paver (+ tipper lorry)	78	18 t	82	82	78	72	69	67	61	54	75	
Trenching													
34	Wheeled excavator	51	7 t	72	66	62	70	63	62	57	53	70	
35	Tracked excavator	27	—	82	72	71	69	69	70	61	54	74	
Cutting concrete slabs													
36	Hand-held circular saw (petrol)	3	300 mm diameter / 9.2 kg	84	86	78	78	77	78	82	80	87	
Lifting formwork for underpass													
37	Wheeled mobile crane	315	80 t	85	73	67	71	72	69	63	56	76	
38	Wheeled mobile crane (idling)	315	80 t	71	62	57	59	63	60	54	46	66	
Pumping water													
40	Electric water pump	15	6 in	71	64	64	67	63	57	54	49	68	
* Drive-by maximum sound pressure level in $L_{r,max}$ (octave bands) and $L_{A,max}$ (overall level)													

Table C.6 Sound level data on opencast coal sites

Ref no.	Equipment	Power rating, kW	Equipment size, weight (mass), capacity	Octave band sound pressure levels at 10 m, Hz							A-weighted sound pressure level, $L_{Aeq,T}(\Delta)$ dB at 10 m	
				63	125	250	500	1k	2k	4k		8k
Breaking out and loading												
1	Tracked excavator	1680	505 t	91	86	80	81	80	78	77	70	85
2	Tracked excavator	1008	240 t	88	91	87	86	83	81	76	68	89
3	Tracked excavator	870	213 t	89	92	83	81	82	78	73	65	86
4	Tracked excavator	382	89 t	86	90	78	74	75	70	62	60	80
5	Tracked excavator	380	90 t	91	92	83	84	80	78	77	70	86
6	Tracked excavator	172	35 t	77	80	79	76	76	75	70	63	81
7	Tracked excavator	128	35 t	84	80	75	74	70	67	64	56	76
8	Tracked excavator	128	28 t	83	83	77	77	75	72	67	61	80
9	Tracked excavator	128	23 t	78	85	77	72	69	68	64	61	76
10	Tracked excavator	107	22 t	83	79	78	76	74	71	65	60	79
11	Tracked excavator	103	19 t	82	84	75	69	69	67	62	57	75
12	Tracked excavator	71	13 t	84	74	71	71	68	66	61	55	74
Haulage												
13	Dump truck *	1417	160 t	97	95	91	91	86	84	79	75	92
14	Dump truck *	783	158 t	89	94	89	85	83	81	76	71	89
15	Dump truck *	746	90 t	94	91	91	87	84	83	77	70	90
16	Articulated dump truck (empty) *	287	40 t	93	90	85	84	83	81	77	69	88
17	Articulated dump truck *	247	28 t	86	84	86	83	79	76	72	67	85
18	Articulated dump truck *	240	35 t	91	90	83	83	81	79	70	61	86
19	Road lorry (empty) *	320	39 t	81	79	75	70	70	70	68	65	76
20	Road lorry (empty) *	313	39 t	81	76	79	70	71	68	64	60	76
21	Road lorry (full) *	270	39 t	96	82	74	73	77	72	71	64	80
22	Road lorry (empty) *	260	39 t	97	85	81	83	76	71	69	64	83
23	Rigid road lorry *	—	—	88	86	80	78	75	73	76	68	82

Table C.6 Sound level data on opencast coal sites (continued)

Ref no.	Equipment	Power rating, kW	Equipment size, weight (mass), capacity	Octave band sound pressure levels at 10 m, Hz							A-weighted sound pressure level, $L_{Aeq,T}$ dB at 10 m	
				63	125	250	500	1k	2k	4k		8k
Dumping load												
24	Dump truck	783	158 t	79	84	81	84	81	80	75	68	86
25	Dump truck	746	90 t	85	86	86	82	81	79	77	68	86
26	Articulated dump truck	287	40 t	88	84	75	73	75	72	68	60	79
27	Articulated dump truck	250	51 t	77	77	76	72	71	69	64	54	76
Bulldozing												
28	Crawler mounted dozer	354	48 t	80	84	76	77	79	81	69	59	85
29	Crawler mounted dozer	250	38 t	83	84	80	77	79	76	86	75	88
30	Crawler mounted dozer	250	35 t	79	87	79	78	82	80	73	66	86
Levelling haul road												
31	Grader *	205	25 t	88	87	83	79	84	78	74	65	86
Front end loaders												
32	Wheeled loader (loading hopper)	198	23 t	83	77	70	70	70	68	64	58	75
33	Wheeled loader (loading lorry)	190	25 t	92	84	83	77	76	74	71	62	82
34	Wheeled loader	184	23 t	82	82	71	73	69	67	66	58	76
Drilling												
35	Tracked hydraulic drilling rig	—	100 mm bore	85	93	78	79	80	79	76	74	86
Diesel bowser												
36	Diesel bowser *	—	—	80	81	84	81	84	85	76	66	89
Water bowser												
37	Water bowser (discharging)	—	—	80	81	75	79	73	74	70	65	81
38	Tractor (towing water bowser) *	—	—	78	86	84	78	78	77	70	69	83
Power for site cabins												
39	Diesel generator	120	150 kVA, 1 500 rpm	79	74	67	64	55	51	45	40	65
Pumping water												
41	Diesel water pump	—	300 kPa / 1 645 rpm	83	76	70	73	74	72	65	58	78

* Drive-by maximum sound pressure level in L_{max} (octave bands) and L_{Amax} (overall level)

Table C.7 Sound level data on dredging

Ref no.	Equipment	Power rating, kW	Equipment size, weight (mass), capacity	Octave band sound pressure levels at 10 m, Hz						A-weighted sound pressure level, $L_{Aeq,T}$ dB at 10 m		
				63	125	250	500	1k	2k		4k	8k
Digging out river bed												
1	Long reach tracked excavator	178	21 m arm / 39 t	74	83	76	75	70	71	63	57	78
Dredging harbour												
2	Grab hopper dredging ship	2461	2136 t	83	91	80	78	78	73	66	58	82

Table C.8 Sound level data on waste disposal sites

Ref no.	Equipment	Power rating, kW	Equipment size, weight (mass), capacity	Octave band sound pressure levels at 10 m, Hz						A-weighted sound pressure level, $L_{Aeq,T}$ dB at 10 m		
				63	125	250	500	1k	2k		4k	8k
Tipping area												
1	Waste compactor	392	54 t	70	78	79	72	77	68	66	62	80
2	Waste compactor	298	—	66	74	78	76	74	70	66	62	79
3	Waste compactor	283	37 t	79	83	71	75	78	70	67	67	80
4	Waste compactor	—	—	72	76	76	70	69	67	63	58	75
5	Waste compactor	226	—	73	75	70	66	68	64	58	50	71
6	Dozer	138	24 t	81	80	75	77	74	69	63	58	78
7	Dozer	138	21 t	73	79	73	72	69	67	61	57	75
8	Dozer	134	50 t	74	76	73	71	71	68	64	58	75
9	Dozer	104	20 t	76	78	71	70	71	65	60	55	74
10	Tracked excavator	96	24 t	67	70	67	65	63	62	60	55	69
Cell excavation area												
11	Tracked excavator	228	45 t	73	81	75	76	73	70	65	60	78
12	Tracked excavator	96	24 t	78	80	71	70	68	67	63	58	74
13	Articulated dump truck *	327	25 t	92	89	83	84	79	75	68	64	85
14	Articulated dump truck *	250	23 t	88	84	82	73	75	71	66	60	80
15	Articulated dump truck *	227	21 t	91	81	76	77	73	72	70	62	79
16	Articulated dump truck *	198	30 t	84	84	81	79	76	73	69	64	81
17	Dozer	142	20 t	82	88	81	80	75	72	63	57	81

Table C.8 Sound level data on waste disposal sites (continued)

Ref no.	Equipment	Power rating, kW	Equipment size, weight (mass), capacity	Octave band sound pressure levels at 10 m, Hz								A-weighted sound pressure level, $L_{Aeq,T}(\frac{A}{1})$ dB at 10 m	
				63	125	250	500	1k	2k	4k	8k		
Waste delivery vehicles													
18	Refuse wagon *	—	—	82	79	78	75	71	72	66	62	78	*
19	Refuse wagon *	283	44 t	88	81	79	76	72	70	64	60	78	*
20	Tipper lorry *	—	—	88	82	74	74	74	73	70	67	79	*
21	Skip wagon *	—	—	82	84	78	75	71	70	65	59	78	*
Pumping water													
22	Diesel surface water pump	—	4 in	70	75	60	58	65	66	59	62	71	
23	Diesel generator for submersible pump	—	—	81	73	57	56	52	49	49	42	62	
Power for temporary site cabin													
24	Diesel generator	—	—	82	57	63	48	45	44	40	33	59	
*	Drive-by maximum sound pressure level in L_{max} (octave bands) and L_{Amax} (overall level)												

Table C.9 Sound level data on hard rock quarries

Ref no.	Equipment	Power rating, kW	Equipment size, weight (mass), capacity	Octave band sound pressure levels at 10 m, Hz							A-weighted sound pressure level, $L_{A,eq,T}(\Delta)$ dB at 10 m	
				63	125	250	500	1k	2k	4k		8k
Drilling blast holes												
1	Tracked mobile drilling rig	317	20 t / 125 mm dia.	86	92	85	88	84	83	78	77	90
2	Tracked mobile drilling rig	270	23 t / 110 mm dia.	94	95	90	91	87	85	80	73	92
3	Tracked mobile drilling rig	186	16 t	77	83	82	84	85	85	84	79	91
4	Tracked mobile drilling rig	321	—	83	84	79	85	82	79	75	71	87
Face shovel loading dump trucks												
5	Tracked hydraulic excavator (mainly engine noise)	400	82 t	90	85	79	80	78	75	70	62	83
6	Tracked hydraulic excavator	235	47 t	95	93	89	89	86	82	76	74	91
7	Wheeled loader	597	94 t	88	88	87	85	86	83	77	70	90
7	Wheeled loader	466	82 t	88	93	84	84	83	81	79	69	88
8	Wheeled loader	370	50 t	89	87	84	82	81	81	72	65	86
9	Wheeled loader	364	56 t	91	94	90	86	86	83	77	69	91
10	Wheeled loader	325	58 t	89	87	85	83	84	80	75	71	88
Breaking boulders/oversized material												
11	Excavator mounted rock breaker	125	29 t	91	89	85	89	87	87	84	80	93
12	Excavator mounted rock breaker	102	23 t	86	86	83	78	80	78	76	71	85
13	Excavator mounted rock breaker	100	22 t	85	88	85	89	92	88	86	81	95
14	Tracked semi-mobile crusher	310	90 t	91	91	88	87	85	83	78	68	90
15	Tracked semi-mobile crusher	250	38 t	98	98	97	94	91	88	82	72	96
Dump trucks on haul roads												
16	Rigid dump truck *	699	90 t	86	89	88	88	86	83	76	70	91
17	Rigid dump truck *	567	64 t	99	95	87	86	84	83	77	73	90
18	Rigid dump truck *	544	60 t	95	97	89	85	83	83	76	75	90
19	Rigid dump truck *	517	63 t	90	91	88	85	83	82	77	73	89
20	Rigid dump truck *	517	60 t	96	97	90	84	84	84	74	76	90
21	Rigid dump truck *	362	41 t	92	91	86	85	84	85	77	77	90
22	Articulated dump truck *	309	40 t	100	97	88	84	82	80	77	68	89

Table C.9 Sound level data on hard rock quarries (continued)

Ref no.	Equipment	Power rating, kW	Equipment size, weight (mass), capacity	Octave band sound pressure levels at 10 m, Hz							A-weighted sound pressure level, $L_{Aeq,T}$ dB at 10 m	
				63	125	250	500	1k	2k	4k		8k
Dump truck discharging into hopper												
23	Rigid dump truck	544	60 t	88	82	77	79	80	79	73	67	85
24	Rigid dump truck	362	40 t	89	84	80	82	80	78	72	64	85
Lorries being loaded from silo												
25	Lorry	310 to 350	32 t to 36 t	80	79	74	76	76	76	73	65	82
Loading chippings into dump trucks												
26	Wheeled loader	320	45 t	89	90	86	82	83	77	75	64	87
27	Wheeled loader	221	30 t	91	81	73	71	71	72	62	59	77

* Drive-by maximum sound pressure level in L_{max} (octave bands) and L_{Amax} (overall level)

Table C.10 Sound level data on other quarries (i.e. sand and gravel)

Ref no.	Equipment	Power rating, kW	Equipment size, weight (mass), capacity	Octave band sound pressure levels at 10 m, Hz							A-weighted sound pressure level, $L_{Aeq,T}$ dB at 10 m	
				63	125	250	500	1k	2k	4k		8k
Face shovel extracting/loading dump trucks												
1	Tracked hydraulic excavator	184	37 t	82	87	82	77	72	70	66	59	80
2	Tracked hydraulic excavator	74	19 t	82	75	72	73	71	70	66	58	76
3	Wheeled loader	198	29 t	88	84	81	84	76	70	68	61	83
4	Wheeled loader	193	31 t	87	87	85	75	76	74	69	62	82
Face shovel loading hopper												
5	Wheeled loader	232	39 t	84	88	81	74	74	71	66	65	80

Table C.10 Sound level data on other quarries (i.e. sand and gravel) (continued)

Ref no.	Equipment	Power rating, kW	Equipment size, weight (mass), capacity	Octave band sound pressure levels at 10 m, Hz								A-weighted sound pressure level, $L_{Aeq,T}$ dB at 10 m
				63	125	250	500	1k	2k	4k	8k	
General wheeled loader operations												
6	Loading sand to lorry	221	30 t	93	78	73	72	76	83	71	57	85
7	Loading sand to lorry	198	29 t	81	79	75	77	71	65	61	53	77
8	Loading sand to lorry	193	23 t	85	83	76	76	75	72	72	61	80
9	Loading sand to lorry	180	21 t	90	79	71	69	71	67	61	55	75
10	Loading gravel to lorry	193	23 t	89	86	87	77	78	77	73	68	85
11	Loading dump truck with pebbles	232	39 t	92	84	84	80	79	78	75	72	85
12	Loading dump truck with pebbles	184	23 t	87	84	82	77	76	74	70	65	82
13	Picking up sand from stockpile	175	23 t	89	80	82	73	70	69	64	57	78
Semi-mobile screen/stockpiler												
14	Screen stockpiler	56	15 t	93	86	79	78	75	71	69	62	81
15	Screen stockpiler	51	17 t	84	82	79	79	74	74	71	64	81
Transport of material												
16	Wheeled loader *	193	31 t	83	89	92	80	71	69	64	58	85
17	Wheeled loader *	184	23 t	77	83	91	75	75	72	65	59	84
18	Articulated dump truck *	309	37 t	87	85	83	81	78	74	71	66	83
19	Articulated dump truck *	239	23 t	98	94	89	85	79	79	70	65	87
Field conveyor system												
20	Conveyor drive unit	42	—	71	69	68	71	75	67	63	57	77
21	Conveyor drive unit	37	—	73	75	73	73	70	68	66	59	76
22	Feed hopper conveyor drive unit	6	—	71	68	62	63	66	62	58	51	69
23	Field conveyor (rollers)	—	—	58	52	52	43	43	42	47	47	53

* Drive-by maximum sound pressure level in L_{r-max} (octave bands) and L_{Amax} (overall level)

Table C.11 General sound level data

Ref no.	Equipment	Power rating, kW	Equipment size, weight (mass), capacity	Octave band sound pressure levels at 10 m, Hz								A-weighted sound pressure level, $L_{Aeq,T}(\Delta)$ dB at 10 m
				63	125	250	500	1k	2k	4k	8k	
Pumping surface water												
1	Diesel water pump	136	—	81	83	77	75	76	75	69	63	81
2	Diesel water pump	25	—	81	71	67	62	65	65	63	59	71
3	Electric water pump	37	—	67	65	65	64	63	63	60	54	69
Lorry movements on access road												
4	Lorry *	350	44 t	82	80	78	75	76	78	75	69	83
5	Lorry *	350	36 t	92	82	77	76	77	72	68	63	80
6	Lorry *	343	29 t	92	82	76	78	77	76	74	68	83
7	Lorry *	313	44 t	87	79	77	74	73	73	70	64	79
8	Lorry *	313	40 t	81	79	79	83	84	81	76	70	88
9	Lorry *	313	32 t	99	82	81	76	78	74	71	66	82
10	Lorry *	310	32 t	91	79	77	74	71	69	64	61	77
11	Lorry *	306	44 t	96	79	75	79	82	80	72	67	86
12	Lorry *	298	44 t	96	80	75	75	74	72	67	60	79
13	Lorry *	283	44 t	84	80	76	74	73	70	67	61	78
14	Lorry *	254	32 t	93	79	76	74	73	72	69	66	79
15	Lorry *	242	32 t	86	94	81	77	80	77	75	69	85
16	Lorry *	235	26 t	86	81	74	76	73	72	69	60	79
17	Lorry *	233	32 t	91	78	74	70	72	74	66	59	78
18	Lorry *	216	32 t	85	78	83	82	86	80	73	69	88
19	Lorry *	201	26 t	87	76	73	81	79	75	68	62	83
20	Lorry *	160	18 t	91	76	79	78	80	76	70	64	83
* Drive-by maximum sound pressure level in L_{Tmax} (octave bands) and L_{Amax} (overall level)												

Table C.12 Supplementary sound level data on piling

Ref. no	Equipment	Pile depth	Width	Energy, power rating	Dolly	Sound power level L_{WA}	Soil	Cycle time	On-time	Activity equivalent continuous sound pressure level $L_{Aeq,T}$ at 10 m (one cycle)
		m	m			dB		min	%	dB
Steel piling										
1	Pressed-in steel tubular piles; power pack pressing unit (does not include ancillary plant including mobile crane)	—	—	225 kW	—	96	—	—	—	68
		—	—	Available up to 4 MN pressing force	—	83	—	—	—	55
2	Hydraulic power pack	—	—	75 kW to 900 kW	—	101 to 114	—	—	100	73 to 86
Driven cast in situ piling										
3	Junttan PM25, hydraulic hammer	16.75	0.38 dia.	4 t, 0.6 m drop	Sand	103 ^{A)}	12 m fill onto stiff clay	30	65	84
4		16.75	0.38 dia.	4 t, 0.6 m drop	Sand	103 ^{A)}		30	65	85
5		16.75	0.38 dia.	4 t, 0.6 m drop	Sand	119 ^{A)}		30	65	101
6		16.75	0.38 dia.	4 t, 0.6 m drop	Sand	117 ^{A)}		30	65	98
7	Junttan PM26, hydraulic hammer	10.90	0.34 dia.	5 t, 0.6 m drop	Sand	104	6 m fill, 4 m alluvium overlying mudstone	30	65	92
8		15.00	0.34 dia.	5 t, 0.6 m drop	Sand	108	5 m fill overlying firm to stiff clay	20	50	80
9		11.70	0.34 dia.	5 t, 0.6 m drop	Sand	132		25	50	107
10		10.30	0.34 dia.	5 t, 0.6 m drop	Sand	117	2 m fill, 7 m alluvium overlying medium dense gravel	20	50	98

Table C.12 Supplementary sound level data on piling (continued)

Ref. no	Equipment	Pile depth	Width	Energy, power rating	Dolly	Sound power level L_{WA}	Soil	Cycle time	On-time	Activity equivalent continuous sound pressure level $L_{Aeq,T}$ at 10 m (one cycle)	
		m	m			dB		min	%	dB	
11	NCK 605, hanging leaders and drop hammer	20.90	0.34 dia.	4 t, 0.9 m drop	Aluminium	121	4 m fill, 3 m v. loose sand, 2 m peat, 2 m v. soft clay, 10 m v. soft silt onto v. dense sand	30	65	93	
12		20.90	0.34 dia.	4 t, 0.9 m drop	Aluminium	146			30	65	61
13		16.50	0.43 dia.	4 t, 0.9 m drop	Timber	88	1 m fill, 10 m alluvium, 2 m loose to medium dense gravel onto stiff clay	40	80	80	
14		17.70	0.43 dia.	4 t, 0.9 m drop	Aluminium	103			40	80	88
15		17.70	0.43 dia.	4 t, 0.9 m drop	Aluminium	122			40	80	96
16		17.70	0.43 dia.	4 t, 0.9 m drop	Plastic	118	4 m fill, 3 m alluvium overlying very dense sand	40	80	90	
17		7.60	0.34 dia.	4 t, 0.9 m drop	Aluminium	142			25	75	101
18		20.80	0.43 dia.	4 t, 0.9 m drop	Aluminium	122	3 m fill, 10 m alluvium, 5 m gravel onto mudstone	40	80	96	
19		11.50	0.34 dia.	4 t, 0.9 m drop	Aluminium	116	2 m fill, 3 m alluvium overlying medium dense gravel	30	65	93	
20		11.10	0.34 dia.	4 t, 0.9 m drop	Aluminium	110			30	65	91
21		14.60	0.38 dia.	4 t, 0.9 m drop	Aluminium	120	2 m fill onto firm becoming stiff clay	40	80	92	
22		11.10	0.34 dia.	4 t, 0.9 m drop	Aluminium	100	2 m fill, 3 m alluvium overlying medium dense gravel	30	65	72	
23		8.30	0.43 dia.	4 t, 0.9 m drop	Aluminium	112			30	65	93
24		15.00	0.38 dia.	4 t, 0.9 m drop	Aluminium	109	2 m fill, 7 m alluvium overlying chalk	30	65	90	
25		15.50	0.34 dia.	4 t, 0.9 m drop	Aluminium	112	2 m fill, 6 m alluvium overlying firm to stiff clay	30	65	91	

Table C.12 Supplementary sound level data on piling (continued)

Ref. no	Equipment	Pile depth	Width	Energy, power rating	Dolly	Sound power level L_{WA}	Soil	Cycle time	On-time	Activity equivalent continuous sound pressure level $L_{Aeq,T}$ at 10 m (one cycle)
		m	m			dB		min	%	dB
26	NCK 605, hanging leaders and drop hammer	15.50	0.38 dia.	4 t, 0.9 m drop	Timber	107	2 m fill, 13 m alluvium overlying medium dense sand	25	50	79
27		14.50	0.34 dia.	4 t, 0.9 m drop	Aluminium	115	5 m fill, 3 m alluvium, 7 m firm to stiff clay onto mudstone	30	65	87
28		16.50	0.34 dia.	4 t, 0.9 m drop	Aluminium	107	7 m fill, 1 m peat, 4 m alluvium, 8 m gravel onto chalk	40	80	79
29		16.50	0.34 dia.	4 t, 0.9 m drop	Aluminium	120		40	80	92
30		19.50	0.43 dia.	4 t, 0.9 m drop	Aluminium	120		40	80	92
31		19.50	0.43 dia.	4 t, 0.9 m drop	Aluminium	109		40	80	81
32	11.50	0.43 dia.	4 t, 0.9 m drop	Timber	113	6 m fill, 4 m firm clay onto medium dense gravel	30	65	85	
33	NCK Atlas, hanging leaders and drop hammer	23.00	0.38 dia.	4 t, 0.9 m drop	Aluminium	106	7 m fill, 1 m peat, 4 m alluvium, 8 m gravel onto chalk	40	80	78
34		23.00	0.38 dia.	4 t, 0.9 m drop	Aluminium	120		40	80	92
Driven precast concrete piling										
35	Junttan PM25, hydraulic hammer	—	—	7 t, 0.6 m drop	Sand	103	—	—	—	94
36		—	—	9 t, 0.7 m drop	Polypenco	106	—	—	—	86
37		—	—	7 t, 0.6 m drop	Polypenco	111	—	—	—	91
38		—	—	7 t, 0.6 m drop	Sand	108	—	—	—	88
39		—	—	7 t, 0.6 m drop	Sand	111	—	—	—	93
Continuous flight auger piling										
40	Soilmecc R622	25.00	0.9 dia.	—	None	106	7 m alluvium, 7 m firm to stiff clay, 2 m medium dense sand, 2 m clay onto sand	133	—	81
41	Soilmecc CM45	11.80	0.4 dia.	—	None	105	8 m fill overlying sandstone	50	95	80
42		17.50	0.45 dia.	—	None	108	5 m fill, 2 m sand onto firm becoming stiff clay	55	95	83
43	Soilmecc CM48	14.80	0.45 dia.	134 kW	None	102	2 m fill, 7 m soft to firm clay, 6 m medium dense clayey sand onto sandstone	80	95	77
44		14.80	0.45 dia.	134 kW	None	98		80	95	73

Table C.12 Supplementary sound level data on piling (continued)

Ref. no	Equipment	Pile depth m	Width m	Energy, power rating	Dolly	Sound power level L_{pWA} dB	Soil	Cycle time Δt min	On-time %	Activity equivalent continuous sound pressure level $L_{Aeq,T}$ at 10 m (one cycle) dB
45	Soilmec R412	12.00	0.6 dia.	155 kW	None	100	2 m fill overlying firm to stiff becoming very stiff clay with limestone bands	55	95	75
46						102	3 m fill overlying siltstone	25	90	76
47						102	5 m fill, 6 m stiff sandy clay onto sandstone	25	90	77
48						102		25	90	77
49						101		25	90	76
Vibroflotation										
50	Vibrocat, top-feed, electric vibrator	3.50	~0.45 dia.	50 kW	None	115	Firm to stiff clay	10	70	85
51	NCK 305, top-feed, electric vibrator	3.00	~0.45 dia.	50 kW	None	119	Mixed medium dense granular / firm cohesive soils	10	70	89
52	Vibrocat, bottom-feed, electric vibrator	3.30	~0.55 dia.	50 kW	None	96		10	70	65
53	Vibrocat, VCC, electric vibrator	8.50	0.43 dia.	50 kW	None	115		25	85	85
54	Minicat, top-feed, electric vibrator	3.40	~0.50 dia.	50 kW	None	108		20	85	77
55	Minicat, top-feed, electric vibrator	3.00	~0.50 dia.	50 kW	None	115		15	80	85
56	NCK 305, top-feed, electric vibrator	3.00	~0.50 dia.	50 kW	None	111	15	80	81	
57	Vibrocat, bottom-feed, electric vibrator	3.0	~0.55 dia.	55 kW	None	102	Soft to firm clay	10	70	72
58	Vibrocat, bottom-feed, electric vibrator	3.70	~0.50 dia.	50 kW	None	119	Mixed medium dense granular/ firm cohesive soils	10	70	89
59	Minicat, top-feed, electric vibrator	4.70	~0.45 dia.	55 kW	None	123		10	70	93
60	Vibrocat, bottom-feed, electric vibrator	6.00	~0.50 dia.	55 kW	None	129		15	80	87
61	Minicat, top-feed, electric vibrator and prebore rig	3.50	~0.50 dia.	55 kW	None	115	Very loose cohesionless soils	10	70	84
62	Minicat, top-feed, electric vibrator	1.70	~0.55 dia.	55 kW	None	110	Loose cohesionless soils	10	70	79

Table C.12 Supplementary sound level data on piling (continued)

Ref. no	Equipment	Pile depth	Width	Energy, power rating	Dolly	Sound power level L_{WA}	Soil	Cycle time	On-time	Activity equivalent continuous sound pressure level $L_{Aeq,T}$ at 10 m (one cycle)
		m	m			dB		min	%	dB
63	Minicat, top-feed, electric vibrator	4.30	~0.40 dia.	55 kW	Polyurethane	113		15	80	83
64	Minicat, top-feed, electric vibrator	4.30	~0.40 dia.	55 kW	Polyurethane	105	Mixed medium dense granular/ firm cohesive soils	15	80	75
65	NCK 305, top-feed, electric vibrator	4.00	~0.50 dia.	55 kW	None	103		15	80	73
66	Vibrocat, bottom-feed, electric vibrator	2.80	~0.55 dia.	55 kW	None	112	Loose to medium dense cohesionless soils	10	70	82
67		2.50	~0.55 dia.	55 kW	None	111		10	70	81
68		2.50	~0.55 dia.	55 kW	None	114		10	70	84
69		3.50	~0.55 dia.	55 kW	None	113		10	70	83
70	Vibrocat, bottom-feed, electric vibrator	—	—	55 kW	None	113		—	—	85
71	Vibrocat, bottom-feed, electric vibrator	—	—	55 kW	None	106	Unknown	—	—	75
72	Vibrocat, VCC, electric vibrator	—	—	55 kW	None	91		—	—	60
Dynamic compaction										
73	—	—	2.4 x 2.4	8 t, 8 m drop	None	102	Refuse / contaminated fill	1	80	81
74	NCK Ajax	—	2.4 x 2.4	8 t, 8 m drop	None	101	Refuse / contaminated fill	1	80	81
75	NCK Ajax	—	2.4 x 2.4	8 t, 12 m drop	None	105	Mixed fill	1	80	84
76	Supra 1100	—	2.4 x 2.4	15 t, 10 m drop	None	101		1	80	81
77	NCK Eiger C120	—	2.4 x 2.4	15 t, 10 m drop	None	102		1	80	81

Table C.12 Supplementary sound level data on piling (continued)

Ref. no	Equipment	Pile depth m	Width m	Energy, power rating	Dolly	Sound power level L_{WA} dB	Soil	Cycle time Δt min	On-time %	Activity equivalent continuous sound pressure level $L_{Aeq,T}$ at 10 m (one cycle) dB
78	NCK Ajax	—	2.4 x 2.4	8 t, 12 m drop	None	102	Refuse / contaminated fill	1	80	82
79		—	2.4 x 2.4	8 t, 12 m drop	None	105		69		
80		—	2.4 x 2.4	8 t, 12 m drop	None	105		78		
81		—	2.4 x 2.4	8 t, 12 m drop	None	99		79		
82		—	2.4 x 2.4	8 t, 12 m drop	None	99		78		
83		—	2.4 x 2.4	8 t, 12 m drop	None	102		81		
84		—	2.4 x 2.4	8 t, 12 m drop	None	110		90		
85		—	2.4 x 2.4	8 t, 12 m drop	None	109		88		
86		—	2.4 x 2.4	8 t, 12 m drop	None	109		88		
87		—	2.4 x 2.4	8 t, 12 m drop	None	107		87		
88		—	2.4 x 2.4	8 t, 12 m drop	None	106		86		
89		—	2.4 x 2.4	8 t, 12 m drop	None	108		87		
90		—	2.4 x 2.4	8 t, 12 m drop	None	107		87		
91		—	2.4 x 2.4	8 t, 12 m drop	None	107		87		
92		—	2.4 x 2.4	8 t, 12 m drop	None	109		88		
93		—	2.4 x 2.4	8 t, 12 m drop	None	111		91		
94		—	2.4 x 2.4	8 t, 12 m drop	None	106		86		
95		—	2.4 x 2.4	8 t, 12 m drop	None	107		86		
96		—	2.4 x 2.4	8 t, 12 m drop	None	109		89		
97	—	2.4 x 2.4	8 t, 12 m drop	None	109	89				
98	—	2.4 x 2.4	8 t, 12 m drop	None	109	88				
99	—	2.4 x 2.4	8 t, 3 m drop	None	104	83				
Coring through existing piles										
100	Bauer BG36 coring reinforced concrete pile	—	—	—	None	—	—	—	—	72 to 87
101	Junttan PM18/30 coring reinforced concrete pile	—	—	—	None	—	—	—	—	76 to 90

A) Owing to local circumstances the attenuation rate was not standard so propagation values have been amended.

Annex D (informative) **Historic sound level data on site equipment and site activities**

NOTE Much of the information given in this annex is reproduced by permission of the Director of the Construction Industry Research and Information Association (CIRIA). The levels recorded represent individual measurements on specific items of plant.

More detailed information is included in CIRIA Report 64 [57].

D.1 General

The data given in this annex are largely historical, and are taken unaltered from the tables originally provided in BS 5228-1:1997 and BS 5228-4:1992. More recent data are provided in Annex C.

Table D.1 provides an index of site equipment. The subsequent table, or tables, that contain sound level data for particular types of equipment is marked by an asterisk; a tick represents other categories of site work in which these types of equipment are also operated.

Tables D.2 to D.12 provide a guide to the sound power levels for stationary and quasi-stationary site equipment, and the equivalent continuous sound pressure levels at 10 m distance from the site activities. For a single noise source, the dimensions of which are small in relation to 10 m, generating noise at a constant level, the equivalent continuous sound pressure level at 10 m distance is 28 dB(A) below the sound power level. Maximum sound pressure levels at 10 m distance from the drive-by of mobile plant are also included.

NOTE The noise emissions of certain categories of plant are governed by regulations implementing EC Directive 2000/14/EC [11], in particular the Noise Emission in the Environment by Equipment for Use Outdoors Regulations 2001 [58] and the Noise Emission in the Environment by Equipment for Use Outdoors (Amendment) Regulations 2005 [59]. The current permissible sound power levels are given in Annex F (Table F.1).

The on-time recorded in the tables is the percentage time that the equipment was working at full power during the measurement period.

D.2 Presentation of data

For guidance on the presentation of data within Tables D.2 to D.12, refer to Annex C.

Table D.1 Index of site equipment referred to in Tables D.2 to D.12

Equipment	Sound level data table										
	D.2	D.3	D.4 and D.5	D.6	D.7	D.8	D.9	D.10 and D.11	D.12	Quarrying	
	Demolition	Site preparation	Piling	Concreting operations	General site activities	Roadworks	Motorway construction	Opencast coal sites	Dredging		
Air hammer pile driver		*									
Asphalt melter						*	✓				
Asphalt spreader						*	✓				
Asphalt spreader and chipping hopper						*	✓				
Auger, crane mounted			*								
Auger, lorry mounted			*								
Batching plant				*							✓
Chip spreader						*	✓				
Circular saw, bench mounted					*						
Club hammer					*						
Coal lorry								*			
Compactor rammer		*									
Compressor		*		*	*	*	✓	✓			✓
Compressor, tractor mounted		✓				*	✓				
Compressor and pneumatic drilling rig								*			✓
Concrete mixer				*							
Concrete pump, lorry mounted				*							
Crane, lorry mounted				*			✓	✓			✓
Crane mounted auger			*								
Crane mounted auger, pile case vibratory driven			*								
Diesel combined rig (rotary)								*			
Diesel dragline								*			✓
Diesel face shovel								*			✓

Table D.1 Index of site equipment referred to in Tables D.2 to D.12 (continued)

Equipment	Sound level data table											
	D.2 Demolition	D.3 Site preparation	D.4 and D.5 Piling	D.6 Concreting operations	D.7 General site activities	D.8 Roadworks	D.9 Motorway construction	D.10 and D.11 Opencast coal sites	D.12 Dredging	Quarrying		
Diesel front end loader (crawler)								*			✓	
Diesel front end loader (wheeled)								*			✓	
Diesel hammer pile driver		*										
Diesel hoist					*							
Diesel hydraulic shovel								*			✓	
Diesel tractor scraper								*			✓	
Double acting air hammer pile driver			*									
Double acting air trenching hammer			*									
Dozer		*				✓		*			✓	
Dragline excavator		*						✓			✓	
Drop hammer pile driver			*									
Dump truck		*				✓		*			✓	
Dumper		*			*							
Electric dragline								*			✓	
Electric face shovel								*			✓	
Electric percussion drill				*								
Electric vibratory pile extractor			*									
Enclosed drop hammer pile driver			*									
Generator (power)				*	*					✓	✓	
Generator (welding)				*	*					✓	✓	
Grader		*						*				
Groove cutter						*	✓					

Table D.1 Index of site equipment referred to in Tables D.2 to D.12 (continued)

Equipment	Sound level data table											
	D.2	D.3	D.4 and D.5	D.6	D.7	D.8	D.9	D.10 and D.11	D.12	Quarrying		
	Demolition	Site preparation	Piling	Concreting operations	General site activities	Roadworks	Motorway construction	Opencast coal sites	Dredging			
Grout mixer and pump				*								
Hand-held electric circular saw					*							
Hand-held hammer	*				✓						✓	
Hydraulic pile driver			*									
Lorry		*			*	*	✓	✓			✓	
Lorry mounted auger			*									
Lorry mounted concrete pump				*								
Lorry mounted crane				*		✓	✓	✓			✓	
Lorry mounted road sweeper						*	✓	✓			✓	
Oscillatory boring machine for bored piling			*			*	✓	✓			✓	
Paving train						*	✓					
Petrol driven chainsaw	*											
Petrol driven disc cutter, hand-held				*							✓	
Pneumatic breaker	*	*		*		*	✓				✓	
Pneumatic chipper/drill				*								
Pneumatic chipping hammer			*	*								
Pneumatic circular saw					*							
Pneumatic concrete grinder				*								
Pneumatic drilling rig and compressor								*			✓	
Pneumatic hammer						*	✓					
Pneumatic hammer fitted with attachment for pinning reinforcing				*								

Table D.1 Index of site equipment referred to in Tables D.2 to D.12 (continued)

Equipment	Sound level data table											
	D.2	D.3	D.4 and D.5	D.6	D.7	D.8	D.9	D.10 and D.11	D.12	Quarrying		
	Demolition	Site preparation	Piling	Concreting operations	General site activities	Roadworks	Motorway construction	Opencast coal sites	Dredging			
Pneumatic rock drill mounted on tracked excavator		*									✓	
Pneumatic rock drill, hand-held					*						✓	
Pneumatic spade		*										
Poker vibrator				*								
Power float				*								
Road planer						*	✓					
Road raiser and lorry						*	✓					
Road roller						*	✓					
Scaffold frames and clips					*							
Scaffold poles and clips					*							
Scraper							*	*			✓	
Ship chain bucket									*			
Site fork lift truck					*			✓			✓	
Tipper lorry		*					✓	✓			✓	
Tracked crane	*			*	*			✓	*		✓	
Tracked crane fitted with excavator attachment		*						✓			✓	
Tracked excavator		*		*		*	*	✓	*		✓	
Tracked excavator fitted with breaker	*											
Tracked excavator fitted with hydraulic rock breaker						*	✓				✓	
Tracked excavator/loader		*				✓	✓	✓			✓	
Tracked loader		*				✓	✓	✓	*		✓	
Tracked pneumatic rock drill		*						✓			✓	

Table D.1 Index of site equipment referred to in Tables D.2 to D.12 (continued)

Equipment	Sound level data table											
	D.2	D.3	D.4 and D.5	D.6	D.7	D.8	D.9	D.10 and D.11	D.12	Quarrying		
	Demolition	Site preparation	Piling	Concreting operations	General site activities	Roadworks	Motorway construction	Opencast coal sites	Dredging			
Tractor		✓				✓	*	✓				
Tractor mounted compressor		✓				*	✓					
Tractor pulling dump truck						✓	*	✓		✓		
Trenching machine		*										
Tripod winch			*									
Truck mixer				*								
Vibratory roller		*				✓	✓			✓		
Water bowser					✓	✓	✓	*				
Water pump		*			*			✓	*	✓		
Wheeled crane					*			✓		✓		
Wheeled excavator/loader		*		*		*	✓	✓		✓		
Wheeled excavator/loader fitted with hydraulic rock breaker						*	✓	✓		✓		
Wheeled loader		*				✓	✓	*	*	✓		

Table D.2 Historic sound level data on demolition

Ref. no	Equipment	Power rating kW	Equipment size, weight (mass), capacity	Sound power level L_{WA} dB	Activity equivalent continuous sound pressure level $L_{Aeq,T}^{(A)}$ at 10 m dB
Dropping ball demolition					
1	Tracked crane	123	—	121	93
Breaking concrete below ground level					
2	Pneumatic breaker	—	20 kg	109	81
Breaking concrete for drainage					
3	Pneumatic breakers (2)	—	{ 35 kg { 35 kg	118	95
		—		121	
Breaking concrete foundation					
4	} Tracked excavator fitted with breaker	—	{ 200 kg·m { 200 kg·m { 200 kg·m	119	91
5		—		119	91
6		—		124	96
Breaking concrete					
7	} Pneumatic breaker	—	{ 18 kg { 25 kg { 27 kg { 35 kg	120	92
8		—		119	91
9		—		116	88
10		—		110	82
Breaking hard ground					
11	Pneumatic breaker	—	27 kg	115	87
Breaking brickwork					
12	Pneumatic breaker	—	35 kg	117	89
Breaking rubble					
13	Pneumatic breaker	—	33 kg	118	90
Sawing timber					
14	Petrol driven chain saw	—	—	114	86
Boarding windows					
15	Hand-held hammer	—	—	112	84

Table D.3 Historic sound level data on site preparation

Ref. no	Equipment	Power rating kW	Equipment size, weight (mass), capacity	Sound power level L_{WA} dB	Activity equivalent continuous sound pressure level $L_{Aeq, T}^{(A)}$ at 10 m dB	
Clearing site						
1	} Wheeled loader	{	41	—	103	75 ^{A)} (15)
2			52	—	101	73 ^{A)} (15)
3			52	—	102	74 ^{A)} (15)
4			52	—	108	80 ^{A)} (5)
5	Tracked loader	31	—	111	83	
6	Tracked loader (idling)	37	—	101	73 ^{A)} (—)	
7	} Tracked loaders	{	37	—	107	79 ^{A)} (10)
8			37	—	110	82
9			37	—	110	82
10			37	—	113	85
11			37	—	118	90
12			41	—	116	88
13			45	—	113	85
14			56	—	108	80
15			56	—	112	84
16			60	—	104	76
17			60	—	113	85
18			61	—	114	86
19			67	—	112	84 ^{A)} (10)
20			72	—	115	87
21	97	—	110	82		
22	Tracked loader	60	—	110	82	
	Lorry	—	—	—	82	
23	Tracked loader (no exhaust silencer)	72	—	118	90	
	Lorry	—	—	—	90	
24	Tracked excavator/loader	46	—	108	80	
25	Tracked excavator	73	—	113	85	
26	} Dozer	{	104	—	116	88
27			239	—	109	81
Ground excavation						
28	} Dozer	{	201	—	115 Ripping	92
			201	—	120 Dozing	92
29	Dozer	290	—	114	86	
30	Dozer (no exhaust silencer)	290	—	124	96	

Table D.3 Historic sound level data on site preparation (continued)

Ref. no	Equipment	Power rating	Equipment size, weight (mass), capacity	Sound power level L_{WA}	Activity equivalent continuous sound pressure level $L_{Aeq,T}^{(A)}$ at 10 m		
		kW		dB	dB		
31	Tracked crane fitted with excavator attachment	52	—	116	88		
32	} Dragline excavator	{ 56	—	109	81		
33				{ 69	—	114	86
34	} Tracked excavator	{ 34	—	111	83		
35				{ 45	—	106	78
36				{ 54	—	110	82
37				{ 63	—	111	83
38				{ 65	—	111	83
39				{ 71	—	114	86
40				{ 72	—	108	80
41	Tracked excavator (idling)	73	—	96	68		
42	Tracked excavator	186	—	116	88		
43	Tracked excavator	60	—	113	85		
	Lorry	—	—	—	85		
44	Tracked excavator	72	—	109	81		
	Lorry	—	—	—	81		
45	Tracked excavator	72	—	110	82		
	Lorry	—	—	—	82		
46	Tracked excavator	72	—	110	82		
	Lorry	—	—	—	82		
47	Tracked excavator/loader	60	—	115	87		
48	} Wheeled loader	{ 90	—	115	87		
49				{ 242	—	123	95
50				{ 410	—	104	76
51	Wheeled loader	37	—	112	84		
	Lorry	—	—	—	84		
52	Wheeled loader	242	—	114	86		
	Dump truck	309	—	109	86		
53	} Tracked loader	{ 37	—	110	82		
54				{ 71	—	111	83
55				{ 205	—	112	84
56	Tracked loader	37	—	110	82		
	Lorry	—	—	—	82		
57	Tracked loader	71	—	108	80		
	Lorry	—	—	—	80		

Table D.3 Historic sound level data on site preparation (continued)

Ref. no	Equipment	Power rating	Equipment size, weight (mass), capacity	Sound power level L_{WA}	Activity equivalent continuous sound pressure level $L_{Aeq,T}^{(A)}$ at 10 m
		kW		dB	dB
58	Tracked loader	138	—	110	82
	Lorry	—	—	—	82
59	Tracked loader	243	—	105	77
	Lorry	310	35 t	105	77
Tipping fill					
60	Dump truck	450	50 t	110	82
Spreading fill					
61	Wheeled excavator/loader	46	—	104	76
62	Dozer	200	—	109	81
63				112	84
64				117	89
Levelling ground					
65	Dozer	46	—	111	81
66				112	84
67				116	88
68	Dozer (blown exhaust)	104	—	122	94
69	Dozer	170	—	112 forward	87
70				115 reverse	87
				117 forward	90
71				118 reverse	90
				218	113 forward
72				108 reverse	85
				218	111
73	289	—	114	86	
74	Grader	87	—	105 forward	77
75				104 reverse	76
76		168	—	112	84
		—	—	111	83
Trenching					
77	Wheeled excavator/loader	46	—	109	81
78				111	83
79				101	73 ^A (10)
80				106	78 ^A (10)
81				107	79
82				108	80
83				110	82

Table D.3 Historic sound level data on site preparation (continued)

Ref. no	Equipment	Power rating	Equipment size, weight (mass), capacity	Sound power level L_{WA}	Activity equivalent continuous sound pressure level
		kW		dB	$L_{Aeq,T}^{(A)}$ at 10 m dB
84	Wheeled excavator/loader	34	—	110	82
	Lorry	—	—	—	82
85	Wheeled excavator/loader	52	—	105	77
86	Water pump	0.6	75 mm bore	100	72
87	} Tracked excavator	{	—	112	84
88				107	79
89				109	81
90				104	76
91				104	76
92	Tracked excavator (plus lorry)	—	—	104	76
93	} Tracked excavator	{	—	110	82 ^{A)} (15)
94				116	88
95				110	82
96	Tracked excavator/loader	45	—	109	81
97	Tracked excavator/loader	52	—	105	77
98	Dumper	13	—	101	73
99	Compressor	—	3.5 m ³ /min	106 ^{B)}	86
	Pneumatic breaker	—	14 kg	113	86
100	Compressor	—	3.5 m ³ /min	112	84
	Pneumatic breaker	—	27 kg	112	84
101	Compressor	—	4 m ³ /min	100	85
	Pneumatic breaker	—	30 kg	113	85
102	} Pneumatic spade	{	—	113	85
103				115	87
104				115	87
105				115	87
106	Trenching machine	25	—	105	77
Trench filling					
107	Wheeled excavator/loader	46	—	110	82
108	Tracked excavator	57	—	97	69
109	Tracked excavator	73	—	108	80
110	Dumper	13	2 t	102	74
111	Tracked loader	42	—	110	82
Unloading and levelling hardcore					
112	Tipper lorry	75	—	113	85
113	Tracked loader	52	—	112	84

Table D.3 Historic sound level data on site preparation (continued)

Ref. no	Equipment	Power rating kW	Equipment size, weight (mass), capacity	Sound power level L_{WA} dB	Activity equivalent continuous sound pressure level $L_{Aeq,T}$ at 10 m dB
Rolling gravel/brick					
114	Road roller	5	—	108	80
Compacting fill					
115	Vibratory roller	9	—	102	74
116	Vibratory roller	50	7 000 kg	106	78
117	Dozer plus vibratory roller	{ 104	—	114	86
		{ —	—	114	86
118	Compactor rammer	—	111 kg	108	80
Compacting sub-base					
119	Compactor rammer	3	—	105	77
120	Compactor rammer	225	—	117	89
Compacting earth					
121	Compactor rammer	—	111 kg	—	91
Ground consolidation drilling					
122	Tracked pneumatic rock drill	—	120 mm piston	122	94
123	Pneumatic rock drill mounted on tracked excavator	{ —	120 mm piston	128	100
124			—	120 mm piston	132
Diaphragm wall construction					
125	Tracked excavator	46	—	113	85

A) L_{A1} Drive-by L_{A1} maximum sound pressure level, L_{Amax} L_{A1} , at 10 m. Values of equipment speed, in kilometres per hour, are given in parentheses.

B) Side panels open.

Table D.4 Historic sound level data on piling: piling operations

Ref no.	Pile	Method		Energy, power rating	Dolly	Sound power level L_{WA}	Soil	Cycle time	On-time	Activity equivalent continuous sound pressure level $L_{Aeq,T}$ at 10 m (one cycle)
		Depth	Width ^{A)}							
						dB			%	dB
Trenching sheets										
1	3	0.4	Double acting air trenching hammer	48 kg·m	Steel	126	Mixed fill	15 min to 30 min	90	97
2	3	0.4				22 kg·m	None	113	Chalk/ballast	12 min
Sheet steel piling										
3	3	0.95	Diesel hammer	5 500 kg·m	None	136	Silt/rock	45 min	65	106
4	Last 1.5	0.95				3 731 kg·m	None	128	Sand/gravel driving	—
5	5	0.48	Air hammer	3 000 kg·m	None	133	Clay	50 min	80	104
6	3	0.48				22 kg piston	None	126	Clay	10 min
7	3	0.95	Double acting air hammer	300 kg·m	None	122	Wet clay extraction	—	100	94
8	8	0.5				2.75 t, 2 m drop	Wood	114	Fill	67 min
9	8	0.5	Drop hammer	2.5 t, 2 m drop	Wood	111	Fill	50 min	40	81
10	11	0.4				2.5 t, 1 m drop	Wood	122	Chalk	—
11	9	0.4	Enclosed drop hammer	3 t	Wood	110	Boulder clay	60 min	50	75
12	4	0.95				220 000 kg/pile	None	94	Clay	120 min
13	6	0.9	Hydraulic	220 000 kg/pile	None	106	Wet clay	12 h	100	78
14	6	0.9				220 000 kg/pile	None	98	Wet clay	12 h
Sheet steel piling (pairs)										
15	8	0.4 each	Enclosed drop hammer	3 t, 1 m drop	Wood/plastic	117	Fill/clay	60 min	75	88
16	8	0.4 each				3 t, 1 m drop	Wood/plastic	109	Fill/clay	52 min

Table D.4 Historic sound level data on piling: piling operations (continued)

Ref no.	Pile	Method		Energy, power rating	Dolly	Sound power level L_{WA}	Soil	Cycle time	On-time	Activity equivalent continuous sound pressure level $L_{Aeq,T}$ at 10 m (one cycle)	
		Depth	Width ^{A)}								
	m					dB			%	dB	
Tubular steel casing/pile cast in place											
17	23	0.4 dia.		4 t, 1 m drop	Aluminium alloy	129	Fill/clay	33 min	60	100	
18	23	0.4 dia.	Drop hammer		Wood	119	Fill/clay	58 min	80	89	
19	23	0.4 dia.			Wood	118	Fill/clay	75 min	50	87	
20	23	0.4 dia.	Wood		122	Chalk	—	50	91		
21	10	0.4 dia.	Diesel hammer	5 500 kg·m	Wood	132	Clay	60 min	50	101	
22	8	1.25	Electric vibratory extractor	24 Hz	None	125	Clay	15 min	35	93	
Impact bored/pile cast in place											
23	14	0.5 dia.	Tripod winch	25 kW	None	103	Hard clay	1.5 days	85	73	
24	9.5	0.5 dia.			None	18 kW	104	Rough/fill/clay/limestone	9 h	85	76
25	10	0.3 dia.			None	12 kW	112	Gravel/clay	4 h	65	84
26	10	0.5 dia.	Pair tripod winches	2 x 16 kW	None	112	Sand fill/wet clay	—	100	83	
H-section steel piling											
27	8	0.37 sq.	Drop hammer	5 t	Wood	125	Clay/flint/chalk	60 min	50	94	
28	10	0.36 sq.	Diesel hammer	6 219 kg·m	None	125	Fill/clay sandstone	30 min	70	96	
Precast concrete piles											
29	10	0.535 dia.	Drop hammer	6 t, 0.5 m drop	Wood	124	Fill	5 min	30	91	
30	25	0.285 sq.			Wood	5 t, 1.0 m drop	123	Clay/flint/chalk	2.5 h	80	87
31	20	0.275 sq.			Wood	4 t, 0.5 m drop	116	Chalk/clay	47 min	60	87
32	20	0.275 sq.			Wood	4 t, 0.5 m drop	116	Fill/clay/sand	67 min	30	82

Table D.4 Historic sound level data on piling: piling operations (continued)

Ref no.	Pile		Method	Energy, power rating	Dolly	Sound power level L_{WA}	Soil	Cycle time	On-time	Activity equivalent continuous sound pressure level $L_{Aeq,T}^{(A)}$ at 10 m (one cycle)	
	Depth	Width ^{A)}									
	m	m				dB			%	dB	
Bored piling/pile cast in place											
33	15	1.5 dia.	Crane mounted auger	Crane 113 kW Donkey 85 kW	None	116	Clay	60 min	55	87	
34	19	1.07 dia.		Crane 100 kW Donkey 75 kW	None	116	Fill/clay	40 min	25	83	
35	13	1 dia.		Crane 116 kW Donkey 82 kW	None	113	Clay	Boring	100	85	
36	26	0.82 dia.		Crane 75 kW Donkey 150 kW	None	118	Clay	Boring	100	90	
37	20	0.75 dia.		Crane 99 kW Donkey 125 kW	None	111	Clay/silt	30 min	30	79	
38	15	0.75 dia.		Crane 58 kW Donkey 97 kW	None	116	Clay	60 min	50	85	
39	10	0.75 dia.		Crane 58 kW Donkey 97 kW	None	112	Clay	40 min	50	82	
40	13	0.61 dia.		Crane 100 kW Donkey 37 kW	None	124	Clay	52 min	15	88	
41	15.7	0.55 dia.		Crane 100 kW Donkey 134 kW	None	112	Clay	90 min	50	81	
42	8	0.4 dia.		Crane 58 kW Donkey 134 kW	None	116	Clay	Boring	100	88	
43	8	0.4 dia.		Crane mounted auger, pile case vibratory driven	—	None	116	Dry clay	—	100	88

Table D.4 Historic sound level data on piling: piling operations (continued)

Ref no.	Pile Depth	Method		Energy, power rating	Dolly	Sound power level L_{WA}	Soil	Cycle time	On-time	Activity equivalent continuous sound pressure level $L_{Aeq,T}(\Delta)$ at 10 m (one cycle)	
		Width ^{A)}									
44	10	0.48 dia		75 kW	None	109	Sand/clay	—	50	79	
45	5	0.25 dia.	Lorry mounted auger		54 kW	None	112	Clay	10 min	50	81
46	4	0.225 dia.			39 kW	None	102	Clay	10 min	30	71
47	33	1.18 dia.	Oscillatory bored	164 kW	None	115	Clay/chalk	8 h	100	81	
48	See Table D.5										
49	See Table D.5										
Sheet steel piling											
50	12	0.4	Double acting diesel hammer	3 790 kgf·m	Steel on fibrous material	135	—	—	100	107	
51	12	0.4			16 500 kgf·m	Not known	140	—	—	100	112
52	12	0.4	Double acting air hammer	560 kgf·m	Steel on fibrous material	134	—	—	100	106	
53	12	0.4	Hydraulic vibratory driver	20.7 kg·m eccentric moment; 26 Hz	None	118	Sand and gravel	—	100	90	
54	8	0.508	Air hammer	415 kgf·m	None	131	Sandy clay overlying boulder clay	—	100	103	
55	8	0.508			415 kgf·m	None	134	Sandy clay overlying boulder clay	—	100	106
56	8	0.508	Drop hammer (hammer and pile enclosed acoustically)	3 t	150 mm greenheart timber plus rope	94	Sandy clay overlying boulder clay	—	100	66	
57	8	0.508			3 t	150 mm greenheart timber plus rope	98	Sandy clay overlying boulder clay	—	100	70
58	10 (4 m exposed)	0.96	Double acting air impulse hammer	15 kN·m	Air cushion	111	—	—	100	83	
59	15 (5 m exposed)	1.05	Hydraulic hammer, enclosed acoustically	60 kN·m	Steel on fibrous material	121	Gravel overlying stiff clay	—	100	93	
60	15	1.05	Hydraulic drop hammer, enclosed acoustically	60 kN·m	Steel on fibrous material	113	Gravel overlying stiff clay	—	100	85	

Table D.4 Historic sound level data on piling: piling operations (continued)

Ref no.	Pile	Method		Energy, power rating	Dolly	Soil power level L_{WA}	Soil	Cycle time	On-time	Activity equivalent continuous sound pressure level $L_{Aeq,T(A)}$ at 10 m (one cycle)
		Depth	Width ^{A)}							
	m	m				dB			%	dB
Tubular casing										
61	23	1.07 dia.	Double acting diesel hammer	{ 6219 kgf·m 16000 kgf·m }	Not known	122	Silt overlying chalk	—	100	94
62	23	1.07 dia.				132	Silt overlying chalk	—	100	
Tubular steel casing/pile cast in place										
63a)	13	0.35 dia.	Drop hammer	{ 3.3 t, 1.2 m drop 3.3 t, 1.2 m drop 3.3 t }	Resilient composite pad	130	Estuarial alluvia	20 min	20	95
63b)	13	0.35 dia.				126	Estuarial alluvia	20 min	30	93
63c)	13	0.35 dia.				120	Estuarial alluvia	20 min	10	82
64a)	14	0.4 dia.	Drop hammer	{ 4 t, 1.2 m drop 4 t, 1.2 m drop 4 t }	Resilient composite pad	132	Dense sand	45 min	40	100
64b)	14	0.4 dia.				125	Dense sand	45 min	20	90
64c)	14	0.4 dia.				118	Dense sand	45 min	5	77
65a)	8	0.35 dia.	Drop hammer, partially enclosed acoustically	{ 3.3 t, 1.2 m drop 3.3 t, 1.2 m drop 3.3 t, 1.2 m drop }	Resilient composite pad	117	Silt/peat/shale/sandstone	25 min	15	81
65b)	8	0.35 dia.				122	Silt/peat/shale/sandstone	25 min	35	89
65c)	8	0.35 dia.				121	Silt/peat/shale/sandstone	25 min	8	82
66a)	8	0.4 dia.	Drop hammer, partially enclosed acoustically	{ 4 t, 1.6 m drop 4 t, 1.6 m drop }	None	129	Stiff to hard sandy clay	30 min	35	96
66b)	8	0.4 dia.				125	Stiff to hard sandy clay	30 min	30	92
67a)	5	0.45 dia.	Internal drop hammer	{ 3 t, 4 m drop 3 t, 4 m drop }	Dry mix aggregate plug	113	Made ground overlying clay	40 min	50	82
67b)	5	0.45 dia.				115	Made ground overlying clay	40 min	50	84
68a)	14	0.4 dia.	Internal drop hammer	{ 3 t, 4 m drop 3 t, 4 m drop }	Dry mix aggregate plug	111	Ballast	—	50	80
68b)	14	0.4 dia.				116	Ballast	—	25	82

Table D.4 Historic sound level data on piling: piling operations (continued)

Ref no.	Pile	Method		Energy, power rating	Dolly	Sound power level L_{WA}	Soil	Cycle time	On-time	Activity equivalent continuous sound pressure level $L_{Aeq,T(A)}$ at 10 m (one cycle)
		Depth	Width ^{A)}							
Impact bored/pile cast in place										
69a)	20	0.5 dia.	} Tripod winch	{ 20 kW	None	106	Fill/ballast/stiff clay	6 h	30	73
69b)	20	0.5 dia.				108				
69c)	20	0.5 dia.	} Tripod winch, driving casing	{ 3/4 t, 1 m drop	Steel	118	Fill/ballast/stiff clay	6 h	2.5	74
69d)	20	0.5 dia.				122				
70a)	25	0.6 dia.	} Tripod winch	{ 20 kW	None	108	Fill/sand/ballast/stiff clay	10 h	30	75
70b)	25	0.6 dia.				113				
70c)	25	0.6 dia.	} Tripod winch, driving casing	{ 3/4 t, 1 m drop	Steel	127	Fill/sand/ballast/stiff clay	10 h	2	82
70d)	25	0.6 dia.				129				
H section steel piling										
71	22.5	0.31 x 0.31 x 0.11	} Diesel hammer	3 703 kgf·m	Steel on fibrous material	127	Sand and silt overlying stiff clay	—	100	99
72	—	0.35 x 0.37 x 0.089				6 219 kgf·m				
73	75	0.3 x 0.3	} Hydraulic drop hammer, enclosed acoustically	{ 36 kN·m	Hardwood	113	Chalk	—	100	85
74	75	0.3 x 0.3				36 kN·m				
75	75	0.3 x 0.3	Hydraulic drop hammer	84 kN·m	Steel on fibrous material	124	Chalk	—	100	96

Table D.4 Historic sound level data on piling: piling operations (continued)

Ref no.	Pile		Method	Energy, power rating	Dolly	Sound power level L_{WA}	Soil	Cycle time	On-time	Activity equivalent continuous sound pressure level $L_{Aeq,T}$ at 10 m (one cycle)
	Depth	Width ^{A)}								
	m	m				dB			%	dB
Precast concrete piles										
76	—	—	Drop hammer	5 t, 0.75 m drop	Not known	114	Fill	—	100	86
77	50	0.29 x 0.29 square section modular (joined)	Hydraulic drop hammer, enclosed acoustically	60 kN·m	Hardwood	107	Chalk	—	100	79
78	50			60 kN·m	Hardwood	111	Chalk	—	100	83
79	20	0.275 x 0.275 square section modular (joined)	Hydraulic hammer	3 t, 0.3 m drop	Hardwood	111	Stiff clay overlying mudstone	—	100	83
80	20			3 t, 0.3 m drop	Hardwood	119	Stiff clay overlying mudstone	—	100	91
81	10	0.275 x 0.275 square section modular (joined)	Hydraulic hammer, partially enclosed acoustically	4 t, 0.3 m drop	Hardwood	109	Clay/gravel overlying mudstone	—	100	81
82	10			4 t, 0.3 m drop	Hardwood	106	Clay/gravel overlying mudstone	—	100	78
83	17	0.285 x 0.285 square section modular (joined)	Drop hammer	5 t, 1 m drop	Wood	114	Silt/sand/gravel	55 min	80	85

Table D.4 Historic sound level data on piling: piling operations (continued)

Ref no.	Pile Depth	Method		Energy, power rating	Dolly	Sound power level L_{WA}	Soil	Cycle time	On-time	Activity equivalent continuous sound pressure level $L_{Aeq,T}(\Delta t)$ at 10 m (one cycle)			
		Width ^{A)}											
84	20	0.08 m ² hexagonal section modular (joined)	Drop hammer, hanging leaders: soft driving	4 t, 0.6 m drop	Wood	114	Alluvium	—	100	86			
85	20	0.08 m ² hexagonal section modular (joined)	Drop hammer, hanging leaders: medium/hard driving	4 t, 0.75 m drop	Wood	121	Stiff clays and gravels	—	100	93			
86	20	0.406 dia. modular shell	Drop hammer driving on mandrel/pile cast in place	5 t, 0.75 m drop	Wood/sisal	114	Fill overlying chalk	41 min	30	82			
87	28	0.444 dia. modular shell				121				Sand/clay/chalk	57 min	30	89
Bored piling/pile cast in place													
88	10	0.45 dia.	Crane-mounted auger: donkey engine in acoustic enclosure	65 kW	None	108	Fill overlying stiff clay	45 min	100	80			
89a)	25	0.6 dia.				110				Sand/gravel/stiff clay	90 min	85	81
89b)	7	0.6 dia.				128				Sand/gravel/stiff clay	90 min	1.5	82
90	15	0.45 dia.	Lorry-mounted auger: donkey engine in acoustic enclosure	90 kW	None	109	Sand/gravel/clay	55 min	100	81			
91	20	0.6 dia.				113				Fill/clay	75 min	100	85
92a)	25	0.9 dia.	Crane-mounted auger	90 kW	None	114	Fill/clay	3 h	95	86			
92b)	25	0.9 dia.				122				Fill/clay	3 h	3	79

Table D.4 Historic sound level data on piling: piling operations (continued)

Ref no.	Pile		Method	Energy, power rating	Dolly	Sound power level L_{WA}	Soil	Cycle time	On-time	Activity equivalent continuous sound pressure level $L_{Aeq,T}$ at 10 m (one cycle)
	Depth	Width ^{A)}								
	m	m				dB		%	dB	
93	30	1.05 dia.	Crane-mounted auger	120 kW	None	117	Ballast/clay	5 h	100	89
94a)	24	2.1 dia.	Crane-mounted auger and drilling bucket: pile bored under bentonite	110 kW	None	112	Alluvia/sands/clay	2 days	50	81
94b)	24	2.1 dia.	Crane-mounted auger and drilling bucket: kelly bar clanging	110 kW	None	121	Alluvia/sands/clay	2 days	2	82
95	40	1.2 dia.	Crane-mounted auger and drilling bucket: pile bored under bentonite	120 kW	None	117	Sands/boulder clay/marl	2 days	50	86
96	20	0.9 dia.	Lorry-mounted auger	110 kW	None	115	Fill/sand/gravel/clay	3 h	100	87
97	20	1.2 dia.		110 kW	None	112	Fill/ballast/clay	6 h	100	84
Continuous flight auger injected piling										
98	11	0.45 dia.	Crane-mounted leaders with continuous flight auger; cement grout injected through hollow stem of auger. Engine/power pack partially enclosed acoustically	90 kW	None	111	Alluvium	30 min	50	80
99	15	0.35 dia.								
100	12	0.45 dia.	Crane-mounted continuous flight auger rig; concrete injected through hollow stem of auger. Engine/power pack partially enclosed acoustically	100 kW	None	109	Gravels overlying chalk	30 min	50	78

Table D.4 Historic sound level data on piling: piling operations (continued)

Ref no.	Pile	Method		Energy, power rating	Dolly	Sound power level L_{WA}	Soil	Cycle time	On-time	Activity equivalent continuous sound pressure level $L_{Aeq,T}(\Delta t)$ at 10 m (one cycle)
		Depth	Width ^{A)}							
	m		m			dB			%	dB
Diaphragm walling										
101	25	1.0 x 4.0		90 kW	None	114	Sands and gravels overlying chalk	12 h	100	86
102	25	1.0 x 4.0	Crane-mounted hydraulically operated trenching grab guided by kelly bar	90 kW	None	116	Sands and gravels overlying chalk	12 h	100	86
103	25	1.0 x 4.5	Crane-mounted rope operated trenching grab	8 t, 10 m drop	None	113	Sands and gravels overlying clay	10 h	80	84
Vibroreplacement/vibrodisplacement										
104a)	4	0.5 dia. approx.	Stone column formation by crane-mounted hydraulically powered vibrating poker. Compressed air flush; nose cone air jets exposed	90 kW	None	110	Miscellaneous fill	15 min	80	81
104b)	4	0.5 dia. approx.	Stone column formation by crane-mounted hydraulically powered vibrating poker. Compressed air flush; nose cone air jets exposed	90 kW	None	117	Miscellaneous fill	15 min	20	82
										85
105a)	—	2.4 x 2.4	Tamping weight raised by large crawler crane	120 kW	None	114	Made ground and fill	10 min	80	85
105b)	—	2.4 x 2.4	Tamping weight released by crane: impact of weight	20 t, 20 m drop	None	125	Made ground and fill	1 drop per min	1.5	79
106a)	—	2.4 x 2.4	Tamping weight raised by large crawler crane	120 kW	None	110	Made ground and fill	10 min	80	81
106b)	—	2.4 x 2.4	Tamping weight released by crane: impact of weight	20 t, 20 m drop	None	122	Made ground and fill	1 drop per min	1.5	76

Table D.4 Historic sound level data on piling: piling operations (continued)

Ref no.	Pile	Method		Energy, power rating	Dolly	Sound power level L_{WA}	Soil	Cycle time	On-time	Activity equivalent continuous sound pressure level $L_{Aeq,T}^{(A)}$ at 10 m (one cycle)
		Depth	Width ^{A)}							
	m		m			dB			%	dB
Installation of vertical band drains										
107a)	7	0.1		Hydraulic vibratory lance starting up	None	50 kW	None	5 min	1	65
107b)	7	0.1		Hydraulic vibratory lance installing band drain	None	50 kW	None	5 min	70	76
107c)	7	0.1		Hydraulic vibratory lance being extracted	None	50 kW	None	5 min	15	79

NOTE 1 Energy and power relationship: $1 \text{ kgf}\cdot\text{m} = 9.81 \text{ joules (J)}$.

NOTE 2 1 t dropped $1 \text{ m} = 9.81 \cdot 10^3 \text{ J} = 9.81 \text{ kJ} = 9.81 \text{ kN}\cdot\text{m}$; $1 \text{ kW} = 10^3 \text{ J/s} = 1 \text{ kJ/s}$.

NOTE 3 Depths, cycle times where quoted and on-times are typical for specific cases but can vary considerably according to ground and other conditions.

^{A)} dia. = diameter; sq. = square section.

Table D.5 Historic sound level data on piling: ancillary operations

Ref. no	Equipment	Power rating	Equipment size, weight (mass), capacity	Sound power level L_{WA}	On-time	Activity equivalent continuous sound pressure level $L_{Aeq,T}^{(A)}$ at 10 m
		kW	kg	dB	%	dB
Cleaning welds on piles						
48	Pneumatic chipping hammer	—	4	116	100	88
Shaping top of bored pile for fitting concrete cap						
49	Pneumatic chipping hammer (2)	—	11 each	119	30	86

Table D.6 Historic sound level data on concreting operations

Ref. no	Equipment	Power rating	Equipment size, weight (mass), capacity	Sound power level L_{WA}	Activity equivalent continuous sound pressure level $L_{Aeq,T}^{(A)}$ at 10 m
		kW		dB	dB
Preparation, mixing and discharging of concrete					
1	Concrete mixer	1.1	0.1 m ³	92	64
2		1.1	0.1 m ³	100	72
3		2	0.14 m ³	89	61
4		2	0.14 m ³	91	63
5		4.1	0.14 m ³	102	74
6		4.1	0.2 m ³	99	71
7		4.1	0.3 m ³	104	76
8		—	0.4 m ³	90	62
9	Batching plant	—	19 m ³ /h	104	76
10		—	27 m ³ /h	106	78
11		—	360 m ³ /day	108	80
12	Truck mixer (discharging)	—	6 m ³	112	84 ^{A)}
Mixing and pumping grout					
13	Grout mixer and pump	34	—	108	80
Pinning reinforcing					
14	Pneumatic hammer fitted with attachment for pinning reinforcement	—	15 kg	118	90
Pumping concrete into bored pile					
15	Truck mixer	22 ^{B)}	—	109	81
16	Lorry mounted concrete pump	130	—	109	81

Table D.6 Historic sound level data on concreting operations (continued)

Ref. no	Equipment	Power rating kW	Equipment size, weight (mass), capacity	Sound power level L_{WA} dB	Activity equivalent continuous sound pressure level $L_{Aeq,T}$ at 10 m dB
Pumping concrete to foundations, and compaction					
17	Lorry mounted concrete pump	97	—	109	81
18	Tracked crane	92	—	109	81
19	Compressor	—	4 m ³ /min	100	72
20	Poker vibrators (5)	2 each poker	—	102 each poker	81
Pumping concrete to 2nd floor					
21	Truck mixer	22 ^{B)}	—	—	74
22	Lorry mounted concrete pump	100	—	106	78
Oversite concreting					
23	Truck mixer	22 ^{B)}	6 m ³	100	72
24	Tracked excavator	63	—	—	72
Placing concrete to office complex superstructure					
25	Truck mixer	22	—	111	83
26	Tracked crane	200	—	116	88
Placing concrete for road foundation					
27	Truck mixer	22 ^{B)}	—	116	88
28	Wheeled excavator/loader	52	—	102	74
Placing concrete and compaction					
29	Truck mixer (2)	—	5 m ³ each	108	
	Tracked crane	62	—	101 (lifting) 94 (idle)	86
	Poker vibrator	3	—	112	
Hosing down truck mixer drum					
30	Truck mixer	—	10 t (6 m ³)	108	80
Pumping concrete to bridge sections and compaction					
31	Lorry mounted concrete pump	97	—	118	90
32	Poker vibrators (5)	2 each poker	—	100 each poker	79
Pumping concrete					
33	Truck mixer	—	6 m ³	96	68
34	Lorry mounted concrete pump	100	—	107	79
35	Truck mixer	—	5 m ³	100	72
36	Lorry mounted concrete pump	100	—	106	78
Placing concrete for bored piles (including hosing down of the truck mixer drum)					
37	Truck mixer	—	5 m ³	114	86

Table D.6 Historic sound level data on concreting operations (continued)

Ref. no	Equipment	Power rating kW	Equipment size, weight (mass), capacity	Sound power level L_{WA} dB	Activity equivalent continuous sound pressure level $L_{Aeq,T}^{(A)}$ at 10 m dB
Placing concrete for building foundations, and compaction					
38	Truck mixer	—	6 m ³	116	88
39	Lorry mounted crane	78	—	116	88
40	Poker vibrators (2)	0.75 each poker	—	98 each poker	73
Compaction of concrete					
41	Generator	—	200 kV·A	122	94
42	Poker vibrator	—	—	122	94
43	{ Compressor Compressor, small petrol driven Poker vibrators (2)	—	3 m ³ /min	105	77
		—	—	—	
		—	—	—	
Floating concrete					
44	Power float	3	—	100	72
Scabbling concrete					
45	{ Compressor Pneumatic chipper	4.1	3.5 m ³ /min	100	83
		—	—	111	
Chipping concrete					
46	{ Pneumatic chipping hammer	—	4 kg	103	75
47		—	4 kg	117	89
48		—	5 kg	110	82
49		—	14 kg	106	78
Grinding foundation slab					
50	Pneumatic concrete grinder	—	225 mm blade	115	87
Remedial work on concrete beam					
51	Pneumatic breaker	—	41 kg	124	96
Repair to wall cladding					
52	Electric percussion drills (2)	—	10 kg	105	78
		—	4 kg	98	
Cutting concrete pipes					
53	Hand-held petrol driven disc cutter	—	—	112	84
Drilling into a concrete beam					
54	Electric percussion drill	—	10 kg	104	89 ^{c)}
Drilling for soil stack passing through concrete floors					
55	Pneumatic chipper/drill	—	4 kg	114	95 ^{c)}

A) Drive-by maximum sound pressure level, $L_{Amax}^{(A)}$, at 10 m.

B) Truck mixer provided with donkey engine.

C) Includes the reverberation of sound within the building.

Table D.7 Historic sound level data on general site activities

Ref. no	Equipment	Power rating kW	Equipment size, weight (mass), capacity	Sound power level L_{WA} dB	Activity equivalent continuous sound pressure level $L_{Aeq,T}$ at 10 m dB			
Dismantling scaffolding								
1	Scaffold poles and clips	—	Various	—	80			
Loading scaffolding								
2	Scaffold poles	—	6 m length	100	72			
3	Scaffold frames and clips	—	2 m × 0.5 m	96	68			
Supplying air to power tools and for general site use								
4	Compressor	26	1.1 m ³ /min	76 front	48			
						79 side	51	
						81 rear	53	
						(Side panel open) 91 side	63	
5		Compressor	26	2.8 m ³ /min	91	63		
6					26	3 m ³ /min	105	77
7			—	3.5 m ³ /min			89	61
8					—	3.5 m ³ /min	98	70
9			—	3.5 m ³ /min			102	74
10					—	3.7 m ³ /min	106	78
11			—	4 m ³ /min			102	74
12					—	4 m ³ /min	108	80
13			—	4 m ³ /min			92	64
14					—	4 m ³ /min	92	64
15			—	4 m ³ /min			93	65
16					—	4 m ³ /min	96	68
17	Compressor (sound reduced)		—	4 m ³ /min			90	62
18	Compressor		—	4.5 m ³ /min	99	71		
19					4.5 m ³ /min	102	74	
20						4.5 m ³ /min	104	76
21		4.5 m ³ /min					107	79
22							4.5 m ³ /min	109
23	Compressor (sound reduced)		—	4.5 m ³ /min				98
24	Compressor		—	5 m ³ /min	95			67
25					7 m ³ /min	98		70
26		7 m ³ /min				100		72
27						7 m ³ /min	100	72
28	Compressor (sound reduced)		—	7 m ³ /min			100	72

Table D.7 Historic sound level data on general site activities (*continued*)

Ref. no	Equipment	Power rating	Equipment size, weight (mass), capacity	Sound power level L_{WA}	Activity equivalent continuous sound pressure level
		kW		dB	$L_{Aeq,T}^{(A)}$ at 10 m dB
29	Compressor	—	8.5 m ³ /min	102	74
30		—	10.5 m ³ /min	105	77
31		—	10.5 m ³ /min	114	86
32		—	13.6 m ³ /min	111	83
33		—	17 m ³ /min	108	80
34		—	17 m ³ /min	111	83
35		—	17 m ³ /min	111	83
36		—	17 m ³ /min	120	92
37		—	17 m ³ /min	123	95
38		—	4.5 m ³ /min	104	83
			7.1 m ³ /min	110	79
39	Compressor (unsilenced)	—	Up to 10 m ³ /min	113 ^{A)}	89 ^{B), C)}
40		—	10 m ³ /min to 34 m ³ /min	117 ^{A)}	93 ^{B), C)}
41		—	Above 34 m ³ /min	121 ^{A)}	85 ^{B), C)}
42	Compressor (sound reduced)	—	Up to 10 m ³ /min	100 ^{A)}	72 ^{B), C)}
43		—	10 m ³ /min to 34 m ³ /min	102 ^{A)}	74 ^{B), C)}
44		—	Above 34 m ³ /min	103 ^{A)}	75 ^{B), C)}
Supplying electricity for power tools, site machines and ancillary equipment					
45	Petrol driven generator	—	1.5 kV·A	95	67
46		—	2 kV·A	105	77
47		—	2 kV·A	111	83
48		—	2.5 kV·A	98	70
49		—	4 kV·A	104	76
50		—	4 kV·A	108	80
51	—	—	7.5 kV·A	100	72
52	Petrol driven generator (power supply for temporary traffic lights)	—	—	94	66
53	Diesel driven generator	9	—	102	74

Table D.7 Historic sound level data on general site activities (*continued*)

Ref. no	Equipment	Power rating	Equipment size, weight (mass), capacity	Sound power level L_{WA}	Activity equivalent continuous sound pressure level $L_{Aeq,T}$ at 10 m
		kW		dB	dB
54	Diesel driven generator (power supply for hydraulic piling rig)	—	—	89	61
55		—	50 kV·A	92	64
56	Diesel driven generator (power supply for tower crane)	—	75 kV·A	110	82
Electric supply for arc welders					
57	Diesel driven generator	—	5 kV·A	104	76
58		—	9 kV·A	107	79
59		—	10 kV·A	103	75
60		—	10 kV·A	108	80
61		—	12.5 kV·A	107	79
62		—	—	100	72
63		—	—	107	79
Drilling concrete					
64	Hand-held pneumatic rock drill	—	14 kg	118	90
Draining trench					
65	Water pump	1	—	95	67
66		1.5	—	100	72
67		41	0.42 m ³ /s	105	77
Pumping water					
68	Water pump	4.5	—	94	66
69		4.5	—	104	76
70		4.5	—	108	80
71		4.5	—	109	81
72		7.5	—	102	74
73		7.5	—	106	78
74		—	7.5 mm bore	100	72
Cutting timber					
75	Hand-held electric circular saw	—	150 mm blade	105	77
76		—	225 mm blade	109	81
77		—	225 mm blade	110	82
78	Circular saw, bench mounted	—	660 mm blade (free running)	106	78

Table D.7 Historic sound level data on general site activities (*continued*)

Ref. no	Equipment	Power rating kW	Equipment size, weight (mass), capacity	Sound power level L_{WA} dB	Activity equivalent continuous sound pressure level $L_{Aeq,T} (A)$ at 10 m dB		
79	Pneumatic circular saw	—	(Cutting 250 mm x 250 mm cedar beam)	103	75		
Hammering							
80	Club hammer	—	1.5 kg	107	79		
Distribution of materials							
81	Dumper	5.5	—	96	68 ^{D)} (1.5)		
82	Dumper (idling)	5.5	—	91	63		
83				6	—	95	67
84				9	—	88	60
85				13	—	92	64
86				13	2 t	95	67
87	Dumper	13	—	103	75 ^{D)} (15)		
88				13	2.25 t	106	78 ^{D)} (10)
89				13	—	110	82 ^{D)} (15)
90	Dumper (pulling away)	13	—	112	84 ^{D)} (—)		
91	Dumper	28	—	117	89 ^{D)} (20)		
92				—	—	107	79 ^{D)} (5)
93	Site fork lift trucks	32	—	104	76 ^{D)} (10)		
94				32	—	116	88 ^{D)} (15)
95				57	—	122	94 ^{D)} (15)
96	Site fork lift trucks (idling)	57	—	105	77		
				57	—	122	94 ^{D)} (15)
97	Diesel hoist	6	—	101	73		
98				6	—	104	76
99				—	1.27	105	77
100	Diesel hoist (poorly maintained)	—	Wheel-barrow (2)	116	88		
Lifting operations							
101	Wheeled crane	4	—	94	66		
102				103	75		
103				110	82		
104				30	—	112	84

Table D.7 Historic sound level data on general site activities (continued)

Ref. no	Equipment	Power rating	Equipment size, weight (mass), capacity	Sound power level L_{WA}	Activity equivalent continuous sound pressure level $L_{Aeq,T}$ at 10 m
		kW		dB	dB
105	Tracked crane	30	—	108	80
106		42	22 t	99	71
107	Tracked crane (moving)	42	22 t	114	86
108	Tracked crane (idling)	56	20 t	99	71
109	Tracked crane	56	—	103	75
110		56	—	106	78
111		56	—	109	81
112		58	34 t	102	74
113		58	—	107	79
114		62	—	101	73
115		62	—	110	82
116		67	—	108	80
117		75	25 t	110	82
118		80	—	99	71
119	100	—	109	81	
120	42	22 t	104	76	
	72	25 t	104	76	
Arrival and departure of vehicles					
121	Lorry (pulling up)	—	10 t	98	70 ^{D)}
122	Lorry (unloading)	—	6 m ³	112	—

A) Average sound power levels.

B) $L_{Aeq,T}$ at 10 m calculated from $L_{WA} - 28$.

C) These are typical noise level values for portable diesel driven compressors both in unsilenced and sound-reduced forms. Source: British Compressed Air Society

D) Drive-by maximum sound pressure level, L_{Amax} , at 10 m. Values of equipment speed, in kilometres per hour, are given in parentheses.

Table D.8 Historic sound level data on roadworks

Ref. no	Equipment	Power rating kW	Equipment size, weight (mass), capacity	Sound power level L_{WA} dB	Activity equivalent continuous sound pressure level $L_{Aeq,T}^{(A)}$ at 10 m dB
Breaking road surface					
1	Pneumatic breaker	—	35 kg	114	86
2		—	35 kg	118	90
3		—	35 kg	121	93
4		—	35 kg	123	95
5	Compressor	—	3.5 m ³ /min	112	91
6	Pneumatic breaker (2)	—	35 kg	115	
7		—	35 kg	115	
8	Compressor	—	4 m ³ /min	106	87
9	Pneumatic breaker	—	35 kg	114	
10	Tractor mounted compressor	39	Integral compressor	122	94
11	Pneumatic breaker	—	27 kg		
12	Wheeled excavator/loader fitted with hydraulic rock breaker	52	—	106	78
13	Tracked excavator fitted with hydraulic rock breaker	73	—	110	82
		—	200 kg		
Removing road surface					
14	Road raiser and lorry	97	—	115	87
Removing broken road surface					
15	Wheeled excavator/loader	57	—	103	75
16	Wheeled excavator/loader Lorry	46	—	108	80 ^{A)} (0.3)
		—	10 t		
Road planing					
17	Road planer	124	—	111	83 ^{A)} (0.3)
Pinning rails for slipform paving					
18	Tractor mounted compressor	41	4 m ³ /min	114	89
19	Pneumatic hammer	—	—	114	
Slipforming concrete road					
20	Paving train	195	—	109	81 ^{A)} (0.4)

Table D.8 Historic sound level data on roadworks (continued)

Ref. no	Equipment	Power rating	Equipment size, weight (mass), capacity	Sound power level L_{WA}	Activity equivalent continuous sound pressure level $L_{Aeq,T}$ at 10 m
		kW		dB	dB
Road surfacing					
21	Asphalt melter	—	—	103	75
22	Asphalt spreader	53	—	110	82 ^{A)} (2)
23	Asphalt spreader and chipping hopper	53	—	114	86 ^{A)} (1.5)
24	Asphalt spreader	90	13 t	101	73 ^{A)} (1.5)
25	{ Road roller Lorry	—	10 t	96	68 ^{A)} (4)
		—	24 t		
26	{ Asphalt spreader Chip spreader Road roller Lorry	90	13 t	108	80 ^{A)} (1.5)
		—	—		
		—	10 t		
		—	—		
27	Road roller (2)	—	10 t each	104	76 ^{A)} (5)
28	} Road roller	{	5	121 ^{B)}	93 ^{A)} (10)
5			105 ^{C)}	77 ^{A)} (10)	
51			101	73	
Road sweeping					
31	Lorry mounted road sweeper	—	—	101	73 ^{A)} (2)
Installation of traffic light controls					
32	Groove cutter	45	—	115	87
Excavating trench					
33	Tracked excavator	46	—	102	74

A) Drive-by maximum sound pressure level, L_{Amax} , at 10 m. Values of equipment speed, in kilometres per hour, are given in parentheses.

B) Travelling on concrete.

C) Travelling on gravel/brick.

Table D.9 Historic sound level data on motorway construction

Ref. no	Equipment	Power rating	Equipment size, weight (mass), capacity	Sound power level L_{WA}	Activity equivalent continuous sound pressure level $L_{Aeq,T}^{(A)}$ at 10 m
		kW		dB	dB
Levelling ground and earth removal					
1	Dozer	109	—	113	85 ^{A)} (10)
2		200	—	104	76 ^{A)} (2)
3		200	—	126	98 ^{A)} (5)
4		200	—	129	101 ^{A)} (5)
5	Dozer (idling)	240	—	101	73
6	Grader	140	—	113	85 ^{A)} (20)
7		150	—	111	83 ^{A)} (10)
8		168	—	111	83 ^{A)} (2)
9		168	—	112	84 ^{A)} (24)
10		168	—	114	86 ^{A)} (2)
11		168	—	110	— (—)
12	Scraper	109	—	118	90 ^{A)} (10)
13	Scraper (unladen)	475	—	120	92 ^{A)} (30)
14	Scraper (laden)	475	—	123	95 ^{A)} (30)
15	Scraper	475	—	125	97 ^{A)} (10)
16		480	—	108	80 ^{A)} (25)
17		480	—	110	82 ^{A)} (2)
18	Dump truck	110	—	118	90 ^{A)} (10)
19		—	20 t	102	74 ^{A)} (10)
20		—	20 t	103	75 ^{A)} (10)
21		—	20 t	104	76 ^{A)} (15)
22		—	20 t	108	80 ^{A)} (10)
23		—	20 t	110	82 ^{A)} (10)
24		—	24 t	104	76 ^{A)} (15)
25		309	—	110	82 ^{A)} (30)
26		309	—	111	83 ^{A)} (30)
27		310	35 t	105	— (—)
28		310	35 t	106	78 ^{A)} (5)
29		310	35 t	109	81 ^{A)} (20)
30		310	35 t	109	81 ^{A)} (30)
31		310	35 t	110	82 ^{A)} (1.5)
32	310	35 t	111	83 ^{A)} (30)	
33	310	35 t	112	84 ^{A)} (35)	
34	310	35 t	113	85 ^{A)} (40)	
35	310	35 t	113	85 ^{A)} (30)	
36	310	35 t	115	87 ^{A)} (40)	
37	310	35 t	119	91 ^{A)} (20)	

Table D.9 Historic sound level data on motorway construction (continued)

Ref. no	Equipment	Power rating	Equipment size, weight (mass), capacity	Sound power level L_{WA}	Activity equivalent continuous sound pressure level $L_{Aeq,T}$ at 10 m
		kW		dB	dB
38	Dump truck (36) ^{B)}	450	50 t	103 laden 110 empty	76
39	Dump truck	450	50 t	103	75 ^{A)} (—)
40		450	50 t	104	76 ^{A)} (5)
41		450	50 t	106	78 ^{A)} (10)
42		450	50 t	110	82 ^{A)} (15)
43		450	50 t	120	92 ^{A)} (35)
44	Dump truck (45) ^{B)}	112	—	108	76
	Scraper	475	—	123	
45	Dump truck (30) ^{B)}	301	—	111	82
	Grader (10) ^{B)}	150	—	111	
	Scraper (50) ^{B)}	475	—	122	
46	Scraper (28) ^{B)}	230	—	123	83
	Dozer with scraper box (48) ^{B)}	200	—	121	
47	Dozer pushing	306	—	122	94
	Scraper	475	—		
48	Tracked excavator	298	—	113	87
	Dumper truck	309	—	110	
49	Tractor pulling dump truck	63	—	113	85
50	Tractor (idling)	63	—	99	71

^{A)} Drive-by maximum sound pressure level, L_{Amax} , at 10 m. Values of equipment speed, in kilometres per hour, are given in parentheses.

^{B)} Number of passes per hour.

Table D.10 Historic sound level data on opencast coal sites: pre 1984

Ref. no	Equipment	Power rating	Equipment size, weight (mass) ^A , capacity	Sound power level L_{WA}	Activity equivalent continuous sound pressure level $L_{Aeq,T}^{(A)}$ at 10 m	
		kW		dB	dB	
Drilling blastholes						
1	Compressor and pneumatic drilling rig	115	—	113	85	
2		160	—	112	84	
3		160	—	114	86	
4		170	—	119	91	
5		170	—	120	92	
6	Diesel powered combined rig (rotary)	160	170 mm borehole	113	85	
7		160	170 mm borehole	114	86	
Breaking out and loading						
8	Diesel powered face shovel (crowd action)	56	Coaling 0.67 m ³ Shovel	110	82	
9		56		111	83	
10		56		112	84	
11		56		113	85	
12		56		113	85	
13		56		114	86	
14		56		114	86	
15		56		114	86	
16		56		114	86	
17		56		114	86	
18		56	115	87		
19		56	115	87		
20		71	Coaling 6.1 m ³ /h	108	80	
21		408		114	86	
22		408	114	86		
23		Diesel powered hydraulic shovel (or back acter)	60	Coaling	108	80
24			77		106	78
25			95		110	82
26			95		111	83
27	95		112		84	
28	95		112		84	
29	95		113		85	
30	95		113		85	
31	101		Coaling		113	85
32	101		Coaling		114	86
33	112		Coaling 3.8 m ³		115	87
34	242		3.8 m ³		115	87
35	242	3.8 m ³	115	87		
36	242	3.8 m ³	116	88		
37	244	3.1 m ³	116	88		
38	336	6.0 m ³	112	84		
39	470	6.5 m ³	117	89		
40	537	7.6 m ³	114	86		
41	665	8.4 m ³	117	89		

Table D.10 Historic sound level data on opencast coal sites: pre 1984 (continued)

Ref. no	Equipment	Power rating	Equipment size, weight (mass) ^{A)} , capacity	Sound power level L_{WA}	Activity equivalent continuous sound pressure level $[A_1] L_{Aeq, T} [A_1]$ at 10 m	
		kW		dB	dB	
42	Electric powered face shovel	225	—	104	76	
43		225	—	110	82	
44		225	—	110	82	
45		225	—	113	85	
46		261	4.6 m ³	105	77	
47		261	4.6 m ³	110	82	
48		261	4.6 m ³	110	82	
49		261	4.6 m ³	113	85	
50		448	9.2 m ³	109	81	
51		448	9.2 m ³	109	81	
52		448	9.2 m ³	111	83	
53		448	9.2 m ³	112	84	
54		Diesel powered dragline	225	—	118	90
55			269	4 m ³	118	90
56	353		4 m ³	109	81	
57	353		4 m ³	111	83	
58	353		4 m ³	112	84	
59	353		4 m ³	113	85	
60	353		4 m ³	114	86	
61	394		3.4 m ³	104	76	
62	394		3.4 m ³	105	77	
63	394		3.4 m ³	109	81	
64	394		3.4 m ³	109	81	
65	408		5.3 m ³	107	79	
66	408		5.3 m ³	109	81	
67	408		5.3 m ³	110	82	
68	408		5.3 m ³	112	84	
69	408		5.3 m ³	113	85	
70	408	5.3 m ³	113	85		
71	408	5.3 m ³	114	86		
72	408	5.3 m ³	114	86		
73	408	5.3 m ³	114	86		
74	408	5.3 m ³	114	86		
75	408	5.3 m ³	122	94		
76	480	5.7 m ³	113	85		
77	480	5.7 m ³	115	87		
78	480	5.7 m ³	115	87		
79	480	5.7 m ³	115	87		
80	480	5.7 m ³	119	91		

Table D.10 Historic sound level data on opencast coal sites: pre 1984 (continued)

Ref. no	Equipment	Power rating	Equipment size, weight (mass) ^{A)} , capacity	Sound power level L_{WA}	Activity equivalent continuous sound pressure level $L_{Aeq,T}^{(A)}$ at 10 m
		kW		dB	dB
81	Electric powered dragline	746	9.2 m ³	110	82
82		1 119	11.5 m ³	110	82
83		1 305	19 m ³	114	86
84		1 305	19 m ³	115	87
85		1 865	24.5 m ³	107	79
86		4 476	50 m ³	111	83
87		4 476	50 m ³	111	83
88		4 476	50 m ³	113	85
89		4 476	50 m ³	113	85
90	Diesel powered front end loader (wheeled)	60	—	104	76
91		60	—	107	79
92		60	—	113	85
93		60	—	114	86
94		97	2.3 m ³	108	80
95		97	2.3 m ³	117	89
96		127	3.05 m ³	112	84
97		127	3.05 m ³	115	87
98		127	3.05 m ³	115	87
99		127	3.05 m ³	116	88
100	Diesel powered front end loader (crawler)	127	3.05 m ³	119	91
101		127	3.05 m ³	120	92
102		280	6.1 m ³	119	91
103		410	6.1 m ³	121	93
104		515	7.6 m ³	121	93
105		60	1.15 m ³	109	81
106		60	1.15 m ³	116	88
107		71	1.34 m ³	112	84
108		71	1.34 m ³	113	85
109		142	2.3 m ³	108	80

Table D.10 Historic sound level data on opencast coal sites: pre 1984 (continued)

Ref. no	Equipment	Power rating	Equipment size, weight (mass) ^{A)} , capacity	Sound power level L_{WA}	Activity equivalent continuous sound pressure level $[A_1] L_{Aeq, T} [A_1]$ at 10 m
		kW		dB	dB
110	Diesel powered dump trucks (4-stroke)	127	—	112	84
111		127	—	115	87
112		336	35 s. tons	112	84
113		336	35 s. tons	113	85
114		336	35 s. tons	114	86
115		336	35 s. tons	115	87
116		336	35 s. tons	117	89
117		336	35 s. tons	117	89
118		336	35 s. tons	117	89
119		336	35 s. tons	117	89
120		336	35 s. tons	118	90
121		336	35 s. tons	118	90
122		336	35 s. tons	118	90
123		336	35 s. tons	118	90
124		336	35 s. tons	119	91
125		448	50 s. tons	115	87
126		448	50 s. tons	116	88
127		448	50 s. tons	116	88
128		448	50 s. tons	117	89
129		448	50 s. tons	117	89
130		448	50 s. tons	117	89
131		448	50 s. tons	117	89
132		448	50 s. tons	118	90
133		448	50 s. tons	118	90
134		448	50 s. tons	118	90
135		448	50 s. tons	118	90
136		448	50 s. tons	118	90
137		448	50 s. tons	118	90
138		448	50 s. tons	118	90
139	448	50 s. tons	119	91	
140	448	50 s. tons	119	91	
141	448	50 s. tons	119	91	
142	448	50 s. tons	120	92	
143	448	50 s. tons	120	92	
144	448	50 s. tons	120	92	
145	448	50 s. tons	120	92	
146	448	50 s. tons	121	93	
147	448	50 s. tons	121	93	
148	448	50 s. tons	121	93	
149	650	85 s. tons	114	86	

Table D.10 Historic sound level data on opencast coal sites: pre 1984 (continued)

Ref. no	Equipment	Power rating	Equipment size, weight (mass) ^{A)} , capacity	Sound power level L_{WA}	Activity equivalent continuous sound pressure level $L_{Aeq,T}$ ^{A)} at 10 m
		kW		dB	dB
150	Diesel powered dump trucks (2-stroke)	324	35 s. tons	121	93
151		324	35 s. tons	122	94
152		370	35 s. tons	124	96
153		370	35 s. tons	125	97
154		370	35 s. tons	127	99
155		370	35 s. tons	128	100
156		395	45 s. tons	120	92
157		395	45 s. tons	122	94
158		395	45 s. tons	125	97
159		395	45 s. tons	126	98
160		395	45 s. tons	127	99
161		395	45 s. tons	128	100
162		407	45 s. tons	120	92
163		407	45 s. tons	121	93
164		407	45 s. tons	121	93
165		433	50 s. tons	120	92
166		433	50 s. tons	121	93
167		433	50 s. tons	121	93
168		433	50 s. tons	121	93
169		433	50 s. tons	122	94
170		454	50 s. tons	120	92
171		488	50 s. tons	119	91
172		488	50 s. tons	120	92
173		488	50 s. tons	121	93
174		488	50 s. tons	121	93
175		488	50 s. tons	124	96
176		522	70 s. tons	120	92
177		522	70 s. tons	120	92
178		522	70 s. tons	121	93
179		522	70 s. tons	121	93
180		522	70 s. tons	122	94
181		522	70 s. tons	125	97
182		746	100 s. tons	—	—
183	746	100 s. tons	120	92	
184	Diesel powered (4-stroke) dump trucks, electric drive	740	100 s. tons	116	88
185		740	100 s. tons	116	88
186		740	100 s. tons	118	90
187		740	100 s. tons	118	90
188		740	100 s. tons	119	91
189		740	100 s. tons	119	91
190		740	100 s. tons	119	91
191		740	100 s. tons	119	91
192		740	100 s. tons	120	92
193		740	100 s. tons	120	92

Table D.10 Historic sound level data on opencast coal sites: pre 1984 (continued)

Ref. no	Equipment	Power rating	Equipment size, weight (mass) ^{A)} , capacity	Sound power level L_{WA}	Activity equivalent continuous sound pressure level $L_{Aeq,T}^{A1}$ at 10 m
		kW		dB	dB
194	Tractor scraper, elevating, diesel powered, 4-stroke	246	16.8 m ³ heaped	112	84
195		246	16.8 m ³ heaped	112	84
196		246	16.8 m ³ heaped	113	85
197		246	16.8 m ³ heaped	113	85
198		246	16.8 m ³ heaped	114	86
Tractor scraper loading and haulage					
199	Tractor scraper, single engine, 4-stroke	336	16 m ³ struck	103	75
200		336	23.7 m ³ heaped	114	86
201		336	23.7 m ³ heaped	114	86
202		336	23.7 m ³ heaped	117	89
203	Tractor scraper, tandem, 4-stroke	526	16 m ³ struck	113	85
204		526	23.7 m ³ heaped	114	86
205		526	23.7 m ³ heaped	115	87
206		526	23.7 m ³ heaped	117	89
207		526	23.7 m ³ heaped	118	90
208		448	18.4 m ³ struck	114	86
209	Tractor scraper tandem, 2-stroke	448	24 m ³ heaped	118	90
210		448	24 m ³ heaped	118	90
211		448	24 m ³ heaped	119	91
212		448	24 m ³ heaped	120	92
213		448	24 m ³ heaped	122	94
214		448	24 m ³ heaped	125	97
215		248	24 m ³ heaped	127	99
216		448	24 m ³ heaped	128	100
217		448	24 m ³ heaped	128	100
218		447	24 m ³ heaped	129	101
219		448	24 m ³ heaped	130	102

Table D.10 Historic sound level data on opencast coal sites: pre 1984 (continued)

Ref. no	Equipment	Power rating	Equipment size, weight (mass) ^A , capacity	Sound power level L_{WA}	Activity equivalent continuous sound pressure level $L_{Aeq,T}^{(A)}$ at 10 m dB	
		kW		dB	dB	
Tractor (bulldozing, push loading, ripping)						
220	}	56	8 820 kg	114	86	
221		56	8 820 kg	117	89	
222		56	8 820 kg	119	91	
223		104	14 270 kg	110	82	
224		104	14 270 kg	114	86	
225		104	14 270 kg	116	88	
226		104	14 270 kg	117	89	
227		104	14 270 kg	117	89	
228		104	14 270 kg	126	98	
229		149	20 230 kg	113	85	
230		149	20 230 kg	116	88	
231		149	20 230 kg	117	89	
232		149	20 230 kg	118	90	
233		224	31 980 kg	113	85	
234		224	31 980 kg	113	85	
235		224	31 980 kg	114	86	
236		224	31 980 kg	115	87	
237		224	31 980 kg	116	88	
238		224	31 980 kg	116	88	
239		224	31 980 kg	116	88	
240		224	31 980 kg	117	89	
241		224	31 980 kg	117	89	
242		224	31 980 kg	117	89	
243		} Tractor, crawler mounted (dozer)	224	31 980 kg	118	90
244			224	31 980 kg	118	90
245			224	31 980 kg	118	90
246	224		31 980 kg	118	90	
247	224		31 980 kg	119	91	
248	224		31 980 kg	120	92	
249	224		31 980 kg	121	93	
250	224		31 980 kg	121	93	
251	224		31 980 kg	123	95	
252	224		31 980 kg	126	98	
253	224		31 980 kg	126	98	
254	239		31 980 kg	118	90	
255	239		31 980 kg	120	92	
256	239		31 980 kg	120	92	
257	239		31 980 kg	120	92	
258	276		31 980 kg	121	93	
259	306		42 780 kg	101	73	
260	306		42 780 kg	115	87	
261	306		42 780 kg	116	88	
262	306		42 780 kg	117	89	
263	306		42 780 kg	120	92	
264	306		42 780 kg	120	92	
265	306		42 780 kg	123	95	
266	306		42 780 kg	125	97	
267	522	77 870 kg	115	87		

Table D.10 Historic sound level data on opencast coal sites: pre 1984 (continued)

Ref. no	Equipment	Power rating	Equipment size, weight (mass) ^{A)} , capacity	Sound power level L_{WA}	Activity equivalent continuous sound pressure level $L_{Aeq,T}^{(A)}$ at 10 m		
		kW		dB	dB		
268	Tractor, wheel mounted (dozer)	225	33 629 kg	116	88		
269				122	94		
270	Motor grader	112	13 620 kg	117	89		
271				118	90		
272				110	82		
273				113	85		
274				114	86		
275				115	87		
276				187	24 520 kg	110	82
277				187	24 520 kg	111	83
278				187	24 520 kg	115	87
279				187	24 520 kg	116	88
280				187	24 520 kg	116	88
281	187	24 520 kg	117	89			
Coal haulage							
282	Coal lorry	160	—	109	81		
283				109	81		
284				109	81		
285				111	83		
286				111	83		
287				111	83		
288				112	84		
289				113	85		
290				113	85		
291				113	85		
292				113	85		
293				113	85		
294				114	86		
295				114	86		
296				115	87		
297				115	87		
298				117	89		
299				118	90		
300				119	91		
301				119	91		

^{A)} s. tons = short tonnes.

Table D.11 Historic sound level data on opencast coal sites: post 1990

Ref. no	Equipment	Power rating kW	Equipment size, weight (mass) ^{A)} , capacity	Average sound power level L_{WA} dB
Drilling blastholes				
1	Compressor and drilling rig (top hammer)	—	100 mm borehole	117
2	Consolidated rig (down-the-hole hammer)	160	—	112
Breaking out and loading				
3	Diesel excavators	60	0.5 m ³	103
4		70	0.5 m ³	102
5		70	0.9 m ³	104
6		110	0.9 m ³	107
7		125	1.0 m ³	103
8		100	1.3 m ³	106
9		110	1.3 m ³	105
10		160	1.4 m ³	106
11		120	1.5 m ³	104
12		125	1.5 m ³	105
13		145	2.0 m ³	108
14		242	3.8 m ³	108
15		250	4.0 m ³	109
16		275	5.0 m ³	114
17		300	6.0 m ³	117
18	435	8.0 m ³	116	
19	610	9.5 m ³	116	
20	750	12.0 m ³	116	
21	870	12.0 m ³	117	
22	1000	14.0 m ³	117	
23	1516	20.0 m ³	120	
Draglines				
24	Diesel	400	5.3 m ³	107
25	Electric	895	9.2 m ³	108
26	Electric	11 689	50.0 m ³	115
Front end loaders				
27	Diesel front end loaders	161	3.8 m ³	107
28		280	5.2 m ³	110
29		515	8.9 m ³	111

Table D.11 Historic sound level data on opencast coal sites: post 1990 (continued)

Ref. no	Equipment	Power rating kW	Equipment size, weight (mass) ^{A)} , capacity	Average sound power level L_{WA} dB	
Dump trucks					
30	Diesel: 4 stroke	}	475	55 s. tons	113
31			485	58 s. tons	118
32			750	85 s. tons	112
33			650	95 s. tons	115
34			960	150 s. tons	118
35			1270	195 s. tons	118
Tractor scrapers					
36	Single engine	340	23.7 m ³	107	
37	Tandem	520	23.7 m ³	109	
Tractor					
38	Crawler mounted dozer	}	104	14.2 t	107
39			123	17.8 t	109
40			410	32.8 t	113
41			212	36.8 t	112
42			276	42.5 t	113
43			460	52.0 t	113
44			575	95.8 t	116
Motor grader					
45	Motor grader	205	27.2 t	112	
Coal haulage					
46	(No data given)				
47	Rigid truck	117	—	109	
48	Rigid truck	170	—	111	
49	Articulated truck	180	—	102	
50	Articulated truck	240	—	110	
Water bowsers					
51	Rigid dump truck	450	—	113	
52	Rigid dump truck	430	—	117	
53	Tractor scraper	215	—	112	

^{A)} s. tons = short tonnes.

Table D.12 Historic sound level data on dredging

Ref. no	Equipment	Power rating kW	Equipment size, weight (mass), capacity	Sound power level L_{WA} dB	Activity equivalent continuous sound pressure level $L_{Aeq,T(A)}$ at 10 m dB
Dredging					
1	Ship chain bucket	—	35 m long	124	96
Digging out river bed					
2	{ Tracked excavator Water pump	46	—	112	} 85
		6	—	104	
Clearing river bank					
3	Tracked loader	37	—	108	80
Dredging gravel					
4	Tracked crane (no exhaust silencer)	92	—	124	96
Loading dredged aggregates					
5	Wheeled loader	93	—	112	84

Annex E (informative) Significance of noise effects

E.1 Example criteria for the assessment of the **A1** potential significance **A1** of noise effects

A1 This annex gives examples only. It does not comprise an exhaustive set of provisions regarding noise effects.

The examples cited in this annex offer guidance that might be useful in the implementation of discretionary powers for the provision of off-site mitigation of construction noise arising from major highways and railway developments [see Note to item a)]. These powers were introduced in the Noise Insulation Regulations 1975 [30, 31, 32] under the Land Compensation Act 1973 [33, 34, 35] (see **A.3.4**) and the Noise Insulation (Railways and other Guided Transport Systems) Regulations 1995 [37] (see **A.3.5**), respectively. Off-site noise mitigation might not be applicable in all circumstances or to other categories of construction project. See also **E.4. A1**

A pragmatic approach needs to be taken when assessing the noise effects of any construction project, i.e. the guidance provided below would generally only apply to projects of significant size, and lesser projects might not need to be assessed or might only require general consideration of noise effects and mitigation. Generally, the local planning authority, or a planning consultant experienced in these matters, will be able to advise as to the extent of the assessment that might be required.

Construction noise assessments are generally undertaken for three main reasons.

- a) *For Environmental Impact Assessments (EIAs).* Most major developments now need to be assessed in accordance with the Town and Country Planning (Environmental Impact Assessment) (England and Wales) Regulations 1999 [47]. This is where the development might result in significant effects upon the environment. Therefore, criteria are needed to allow these assessments to be undertaken. **A1** Text deleted **A1**
- b) *Assessments for developments that do not require EIA.* Construction noise assessments are sometimes required by developers to advise on the likely effects that might arise and appropriate actions that might need to be taken to minimize effects.
- c) *Control of Pollution Act (CoPA) 1974 [9], Section 61, "Applications for prior consent for work on construction sites".* Applications under this section of the CoPA are often found to be desirable and useful by both the local authority and the contractor. The applications would usually include (as identified in the CoPA):
 - 1) details of the works and the method by which they are to be carried out; and
 - 2) the steps proposed to be taken to minimize noise resulting from the works.

However, it is good practice to carry out construction noise predictions to provide additional information and to determine, for projects of significant size, any eligibility for noise insulation or temporary re-housing. By gaining consent under Section 61, the contractor gains protection from action under Section 60 of the CoPA, whereby a stop or enforcement notice cannot be

A1 NOTE The assessments can include likely eligibility for noise insulation or temporary re-housing, as forms of mitigation, but such eligibility needs to be confirmed later in the process when a contractor is appointed and detailed method statements and programme information are available. **A1**

served on the contractor, as long as the works are carried out in accordance with the details in the application.

This annex describes methods to identify the likely significance of noise levels from surface construction activity.

E.2 **A1** Potential significance based on fixed noise limits **A1**

For projects of significant size such as the construction of a new railway or trunk road, historically, there have been two approaches to determining whether construction noise levels **A1** could be significant. **A1**

The older and more simplistic is based upon exceedance of fixed noise limits which were originally promoted by the Wilson Committee in their report on noise [60] as presented to Parliament in 1963. These noise limits were then included in Advisory Leaflet 72 [61], first published in 1968; the accompanying wording was subsequently revised and the 1976 version is quoted below:

“Noise from construction and demolition sites should not exceed the level at which conversation in the nearest building would be difficult with the windows shut. The noise can be measured with a simple sound level meter, as we hear it, in A-weighted decibels (dB(A))– see note below. Noise levels, between say 07.00 and 19.00 hours, outside the nearest window of the occupied room closest to the site boundary should not exceed:

- 70 decibels (dBA) in rural, suburban and urban areas away from main road traffic and industrial noise;
- 75 decibels (dBA) in urban areas near main roads in heavy industrial areas.

These limits are for daytime working outside living rooms and offices. In noise-sensitive situations, for example, near hospitals and educational establishments – and when working outside the normal hours say between 19.00 and 22.00 hours – the allowable noise levels from building sites will be less: such as the reduced values given in the contract specification or as advised by the Environmental Health Officer (a reduction of 10 dB(A) may often be appropriate). Noisy work likely to cause annoyance locally should not be permitted between 22.00 hours and 07.00 hours.”

The above principle has been expanded over time to include a suite of noise levels covering the whole day/week period taking into account the varying sensitivities through these periods. **A1** Examples are provided in E.3.2 (see Table E.1) and in E.4 (see Table E.2), and the levels shown in Table E.2 are often used as limits above which noise insulation would be provided if the temporal criteria are also exceeded. **A1**

E.3 **A1** Potential significance **A1** based upon noise change

E.3.1 General

An alternative and/or additional method to determine the **A1** potential significance **A1** of construction noise levels is to consider the change in the ambient noise level with the construction noise. **A1** Text deleted **A1** There are two main methods, both with similar approaches, of which examples are provided in E.3.2 and E.3.3.

E.3.2 Example method 1 – The ABC method

\square_{A1} Table E.1 shows an example of the threshold of potential significant effect at dwellings when the site noise level, rounded to the nearest decibel, exceeds the listed value. The table can be used as follows: for the appropriate period (night, evening/weekends or day), the ambient noise level is determined and rounded to the nearest 5 dB. This is then compared with the site noise level. If the site noise level exceeds the appropriate category value, then a potential significant effect is indicated. The assessor then needs to consider other project-specific factors, such as the number of receptors affected and the duration and character of the impact, to determine if there is a significant effect. \square_{A1}

Table E.1 Example threshold of \square_{A1} potential significant \square_{A1} effect at dwellings

Assessment category and threshold value period	Threshold value, in decibels (dB) \square_{A1} ($L_{Aeq, T}$) \square_{A1}		
	Category A ^{A)}	Category B ^{B)}	Category C ^{C)}
Night-time (23.00–07.00)	45	50	55
Evenings and weekends ^{D)}	55	60	65
Daytime (07.00–19.00) and Saturdays (07.00–13.00)	65	70	75

\square_{A1} NOTE 1 A potential significant effect is indicated if the $L_{Aeq, T}$ noise level arising from the site exceeds the threshold level for the category appropriate to the ambient noise level.

NOTE 2 If the ambient noise level exceeds the Category C threshold values given in the table (i.e. the ambient noise level is higher than the above values), then a potential significant effect is indicated if the total $L_{Aeq, T}$ noise level for the period increases by more than 3 dB due to site noise. \square_{A1}

NOTE 3 Applied to residential receptors only.

A) Category A: threshold values to use when ambient noise levels (when rounded to the nearest 5 dB) are less than these values.

B) Category B: threshold values to use when ambient noise levels (when rounded to the nearest 5 dB) are the same as category A values.

C) Category C: threshold values to use when ambient noise levels (when rounded to the nearest 5 dB) are higher than category A values.

D) 19.00–23.00 weekdays, 13.00–23.00 Saturdays and 07.00–23.00 Sundays.

E.3.3 Example method 2 – 5 dB(A) change

\square_{A1} Noise levels generated by site activities are deemed to be potentially significant if the total noise (pre-construction ambient plus site noise) exceeds the pre-construction ambient noise by 5 dB or more, subject to lower cut-off values of 65 dB, 55 dB and 45 dB $L_{Aeq, T}$ from site noise alone, for the daytime, evening and night-time periods, respectively; and a duration of one month or more, unless works of a shorter duration are likely to result in significant effect. \square_{A1}

These evaluative criteria are generally applicable to the following resources:

- residential \square_{A1} buildings \square_{A1} ;
- hotels and hostels;
- buildings in religious use;
- buildings in educational use;
- buildings in health and/or community use.

A1 For public open space, the impact might be deemed to cause significant effects if the total noise exceeds the ambient noise ($L_{Aeq, T}$) by 5 dB or more for a period of one month or more. However, the extent of the area impacted relative to the total available area also needs to be taken into account in determining whether the impact causes a significant effect. **A1**

E.4 **A1** Example of thresholds used to determine the eligibility for noise insulation and temporary rehousing **A1**

A1 COMMENTARY ON E.4

If the contractor has applied best practicable means to the provision of mitigation, i.e. all reasonable measures have been taken to reduce the noise levels, but levels are still such that widespread community disturbance or interference with activities or sleep is likely to occur, there are two further provisions that can be made if the construction activities are likely to continue for a significant period of time either continuously or sporadically. These are as follows.

- a) *Noise insulation (NI). This is the provision of secondary glazing to the windows of affected habitable rooms. Additional ventilation provision might also be necessary to allow the windows to be kept closed whilst maintaining the appropriate number of air changes in the room. Secondary glazing increases attenuation and this can provide a significant improvement to the internal noise environment.*
- b) *Temporary or permanent re-housing (TRH). Where construction noise levels are such that noise insulation will not provide sufficient attenuation to prevent disturbance or interference with activities or sleep, then the occupants can be temporarily re-housed away from the construction site. However, if the nature of the construction activities means that re-housing would be necessary for a significant extent of time, e.g. in excess of six months, then there might be advantages in offering permanent re-housing, i.e. the property would be purchased by the developer and the occupants would purchase another property elsewhere. The property would then remain vacant or be used by site personnel for the duration of the works, after which it can be re-sold. **A1***

Where, in spite of the mitigation measures applied and any Section 61 consents under the Control of Pollution Act 1974 [9], noise levels at some properties are expected to exceed trigger levels for the periods defined below, a scheme for the installation of noise insulation or the reasonable costs thereof, or a scheme to facilitate temporary rehousing of occupants, as appropriate, will be implemented by the developer or promoter. The scheme will include provision for the notification of affected parties.

A1 Noise insulation, or the reasonable costs thereof, will be offered by the developer or promoter to owners, where applied for by owners or occupiers, subject to meeting the other requirements of the proposed scheme, where the construction of the development causes, or is expected to cause, a measured or predicted airborne construction noise level that exceeds either of the following at property lawfully occupied as a permanent dwelling:

- the noise insulation trigger levels presented in Table E.2 for the corresponding times of day;

- a noise level 5 dB or more above the existing pre-construction ambient noise level for the corresponding times of day;

whichever is the higher;

and for a period of 10 or more days of working in any 15 consecutive days or for a total number of days exceeding 40 in any 6 consecutive months. $\langle A_1 \rangle$

Table E.2 Examples of time periods, averaging times and noise levels associated with the determination of eligibility for noise insulation

Time	Relevant time period	Averaging time, T	Noise insulation trigger level dB $L_{Aeq,T}$ ^{A)}
Monday to Friday	07.00 – 08.00	1 h	70
	08.00 – 18.00	10 h	75
	18.00 – 19.00	1 h	70
	19.00 – 22.00	3 h	65
	22.00 – 07.00	1 h	55
Saturday	07.00 – 08.00	1 h	70
	08.00 – 13.00	5 h	75
	13.00 – 14.00	1 h	70
	14.00 – 22.00	3 h	65
	22.00 – 07.00	1 h	55
Sunday and Public Holidays	07.00 – 21.00	1 h	65
	21.00 – 07.00	1 h	55

^{A)} All noise levels are predicted or measured at a point 1 m in front of the most exposed of any windows and doors in any façade of any eligible dwelling.

$\langle A_1 \rangle$ Temporary rehousing, or the reasonable costs thereof, will be offered by the developer or promoter to owners, where applied for by owners or occupiers, subject to meeting the other requirements of the proposed scheme, where the construction of the development causes, or is expected to cause, a measured or predicted airborne construction noise level that exceeds either of the following at property lawfully occupied as a permanent dwelling:

- a noise level 10 dB above any of the trigger noise levels presented in Table E.2 for the corresponding times of the day; or
- a noise level 10 dB above the pre-construction ambient noise level for the corresponding times of the day;

whichever is the higher;

and for a period of 10 or more days of working in any 15 consecutive days or for a total number of days exceeding 40 in any 6 consecutive months. $\langle A_1 \rangle$

$\langle A_1 \rangle$ Non-residential buildings the occupants of which are likely to be particularly sensitive to noise $\langle A_1 \rangle$ (these include commercial and educational establishments, hospitals and clinics) will be subject to individual consideration by the developer or promoter, upon application by the affected party.

E.5 Construction works involving long-term substantial earth moving

A1 Where construction activities involve large scale and long term earth moving activities, then this is more akin to surface mineral extraction than to conventional construction activity. In this situation, the guidance contained within the Technical Guidance to the National Planning Policy Framework [15] needs to be taken into account when setting criteria for acceptability.

The Technical Guidance states:

“Subject to a maximum of 55 dB(A) LAeq, 1h (free field), mineral planning authorities should aim to establish a noise limit at the noise-sensitive property that does not exceed the background level by more than 10 dB(A). It is recognised, however, that in many circumstances it will be difficult to not exceed the background level by more than 10 dB(A) without imposing unreasonable burdens on the mineral operator. In such cases, the limit set should be as near to that level as practicable during normal working hours (0700–1900) and should not exceed 55 dB(A) LAeq, 1h (free field). Evening (1900–2200) limits should not exceed background level by more than 10 dB(A) and night-time limits should not exceed 42 dB(A), LAeq, 1h (free field) at noise-sensitive dwellings.”

Based upon the above, it is suggested that the limit of 55 dB $L_{Aeq, 1h}$ is adopted for daytime construction noise for these types of activities but only where the works are likely to occur for a period in excess of six months. Precedent for this type of approach has been set within a number of landmark appeal decisions associated with the construction of ports.

Other recommendations with regard to noise emissions given in paragraphs 28 to 31 of the Technical Guidance to the National Policy Planning Framework [15] should also be taken into account, where appropriate. **A1**

Annex F (informative) Estimating noise from sites

F.1 Factors for consideration

Some means of predicting expected levels of noise from sites are useful whether or not noise limits are to be imposed.

Before work starts the following need to be considered.

- a) Local authorities need to know the expected levels of site noise in order that assessments can be made as to whether potential problems exist and whether controls are necessary. They also need to ensure that any noise limits proposed are practicable for the developments concerned and that the limits are capable of protecting the community from excessive noise.
- b) Developers, architects and engineers need to know whether their intended site operations will cause noise problems and, if so, whether the operations will be able to conform to the specified noise limits.
- c) Contractors need to select the most appropriate plant in accordance with any specified limits. They also need to know at the tender stage what noise controls are necessary so that they can make appropriate cost allowances.

As explained in 6.2, site noise can be assessed in terms of the equivalent continuous sound level and/or in terms of the maximum level. The level of sound in the neighbourhood that arises from a site will depend on a number of factors. The estimation procedures described in this annex take into account the more significant factors, these being:

- 1) the sound power outputs of processes and plant;
- 2) the periods of operation of processes and plant;
- 3) the distances from sources to receiver;
- 4) the presence of screening by barriers;
- 5) the reflection of sound;
- 6) soft ground attenuation (see F.2.2.1).

Other factors such as meteorological conditions (particularly wind speed and direction) and atmospheric absorption can also influence the level of noise received. The estimation of the effects of these factors is complicated, not least because of interaction between these factors, and is beyond the scope of this standard. In general, at short distances (say less than 50 m), the size of any effects arising from these factors will be small, whereas at longer distances there will be a tendency towards an increase in sound attenuation. Meteorological conditions can result in increased noise levels due to focusing of the sound and this can be important, for example, where screening is present. So far as is known, the estimating procedures described are applicable also to sound travelling over areas of water (wide rivers, harbours, lakes, etc.).

F.2 Methods of calculation

F.2.1 General

Site noise is produced by many different activities and types of plant, the noise from which varies not only in intensity and character but also in location and over time. There can also be many combinations of these activities of both a static and a mobile nature. However, reasonably accurate predictions can be made by approaching the problem in a logical way and by analysing all activities involved. The starting point in predicting noise levels is to determine the noise level of the source(s). There are three preferred means of obtaining the necessary data.

- a) Carry out or obtain noise measurements of a similar item of plant, operating in the same mode and at the same power over a representative time period including a sufficient number of operating cycles. The measurements may be taken at any appropriate distances but are generally taken at 10 m; measurements at other distances generally need to be corrected back to 10 m for reference purposes.
- b) Use the sound power levels and values of activity $L_{Aeq,T}^{(A_1)}$ given in Annexes C and D. Many of the measurements in Annex D were carried out prior to the introduction of quieter plant as a result of the implementation of EC noise limits; on this basis, there is a clear preference to use data contained within Annex C, where identical or appropriately similar plant are included, as opposed to using older data from Annex D. However, older plant might still be in operation on some sites and the data could then be relevant. The percentage on-times where quoted in the tables only relate to the period over which the measurement was taken.
- c) Obtain the maximum permitted sound power level of the plant under EC Directive 2000/14/EC [11]. Table F.1 shows the current relevant values, which relate to static tests on full power. It is intended to introduce a dynamic test for the earth-moving equipment listed in Table F.1 and to lower the limits progressively. Adjust the sound power levels quoted in Table F.1 to allow for variations of power under typical working conditions over the relevant assessment period (e.g. 1 h, 12 h). Apply a further correction for the distance ratio (see Table F.2).

The method given in item a) is likely to provide the most accurate prediction.

Table F.1 EC noise limits for certain items of construction equipment

Type of equipment	Net installed power, P	Cutting width, L	Electric power, $P_{el}^{A)}$	Mass of appliance, m	Permissible sound power level, L_{WA} , re 1 pW	
					Stage I	Stage II
	kW	cm	kV·A	kg	dB	
Compaction machines (vibrating rollers, vibratory plates, vibratory rammers)	$P \leq 8$				108	105 ^{B)}
	$8 < P \leq 70$				109	106 ^{B)}
	$P > 70$				$89 + 11 \lg P$	$86 + 11 \lg P^{B)}$
Tracked dozers, tracked loaders, tracked excavator-loaders	$P \leq 55$				106	103 ^{B)}
	$P > 55$				$87 + 11 \lg P$	$84 + 11 \lg P^{B)}$
Wheeled dozers, wheeled loaders, wheeled excavator-loaders, dumpers, graders, loader-type landfill compactors, combustion-engine driven counterbalanced lift trucks, compaction machines (non-vibrating rollers), paver-finishers, hydraulic power packs	$P \leq 55$				104	101 ^{B)}
	$P > 55$				$85 + 11 \lg P$	$82 + 11 \lg P^{B)}$
Mobile cranes	$P \leq 55$				104	101 ^{C)}
	$P > 55$				$85 + 11 \lg P$	$82 + 11 \lg P^{C)}$
Excavators, builders' hoists for the transport of goods, construction winches, motor hoes	$P \leq 15$				96	93
	$P > 15$				$83 + 11 \lg P$	$80 + 11 \lg P$
Hand-held concrete-breakers and picks				$m \leq 15$	107	105
				$15 < m < 30$	$94 + 11 \lg m$	$92 + 11 \lg m^{B)}$
				$m > 30$	$96 + 11 \lg m$	$94 + 11 \lg m$
Tower cranes					$98 + \lg P$	$96 + \lg P$
Welding and power generators			$P_{el} \leq 2$		$97 + \lg P_{el}$	$95 + \lg P_{el}$
			$2 < P_{el} \leq 10$		$98 + \lg P_{el}$	$96 + \lg P_{el}$
			$10 > P_{el}$		$97 + \lg P_{el}$	$95 + \lg P_{el}$
Compressors			$P \leq 15$		99	97
			$P > 15$		$97 + 2 \lg P$	$95 + 2 \lg P$

Table F.1 EC noise limits for certain items of construction equipment (continued)

Type of equipment	Net installed power, P kW	Cutting width, L cm	Electric power, P_{el} ^{A)} kV·A	Mass of appliance, m kg	Permissible sound power level, L_{WA} , re 1 pW		
					Stage I	Stage II	
Lawn mowers, lawn trimmers, lawn-edge trimmers		$L \leq 50$			98	96	
					$50 < L \leq 70$	100	98
					$70 < L \leq 120$	100	100
					$L > 120$	105	105

The permissible sound power level is to be rounded up or down to the nearest integer number (less than 0.5, use lower number; greater than or equal to 0.5, use higher number).

lg is an abbreviation used in EC Directive 2000/14/EC [11] to represent logarithm to the base 10.

Stage I limits came into force on 3 January 2003 and Stage II limits came into force on 3 January 2006, with the exceptions noted below.

^{A)} P_{el} for welding generators: conventional welding current multiplied by the conventional load voltage for the lowest value of the duty factor given by the manufacturer. P_{el} for power generators: prime power according to BS ISO 8528-1:2005, 13.3.2.

^{B)} For the following types of equipment the figures for Stage I continue to apply for Stage II:

- walk-behind vibrating rollers;
- vibratory plates (>3 kW);
- vibratory rammers;
- dozers (steel tracked);
- loaders (steel tracked >55 kW);
- combustion-engine driven counterbalanced lift trucks;
- compacting screed paver-finishers; and
- hand-held internal combustion-engine concrete-breakers and picks (15 < m < 30).

^{C)} For single engine mobile cranes the figures for Stage II came into force on 4 January 2008.

Table F.2 Relationship of distance ratio and on-time correction factor for slow moving plant

Distance ratio, D	Correction factor, F
0.5	1.00
0.7	0.80
1	0.63
1.5	0.50
2	0.40
3	0.28
4	0.20
5	0.16
6	0.13
7	0.10
8	0.09
9	0.08
10	0.08
>10	0.06

NOTE $D = l_{tr}/d_{min}$

where:

l_{tr} is the traverse length (see 3.17);

d_{min} is the minimum distance from the plant to the receiver location.

(See F.2.7.1.3.)

A general approach to the prediction of site noise is shown in Figure F.1, where four methods of calculating $\overline{A_1} L_{Aeq, T} \overline{A_1}$ noise levels are indicated. Examples of methods that can be used are given in F.2.2 to F.2.5. In practice, noise prediction at a point of interest might involve a combination of all four methods. The use of other methods is not precluded but might need agreement with the parties concerned.

The general methods of calculation given in F.2.2 to F.2.5 will be suitable for many situations. Nevertheless, these methods have been developed in relation to construction sites and have only been tested on such sites. They do not preclude the use of more precise methods.

Figure F.1 Flow chart for the prediction of site noise

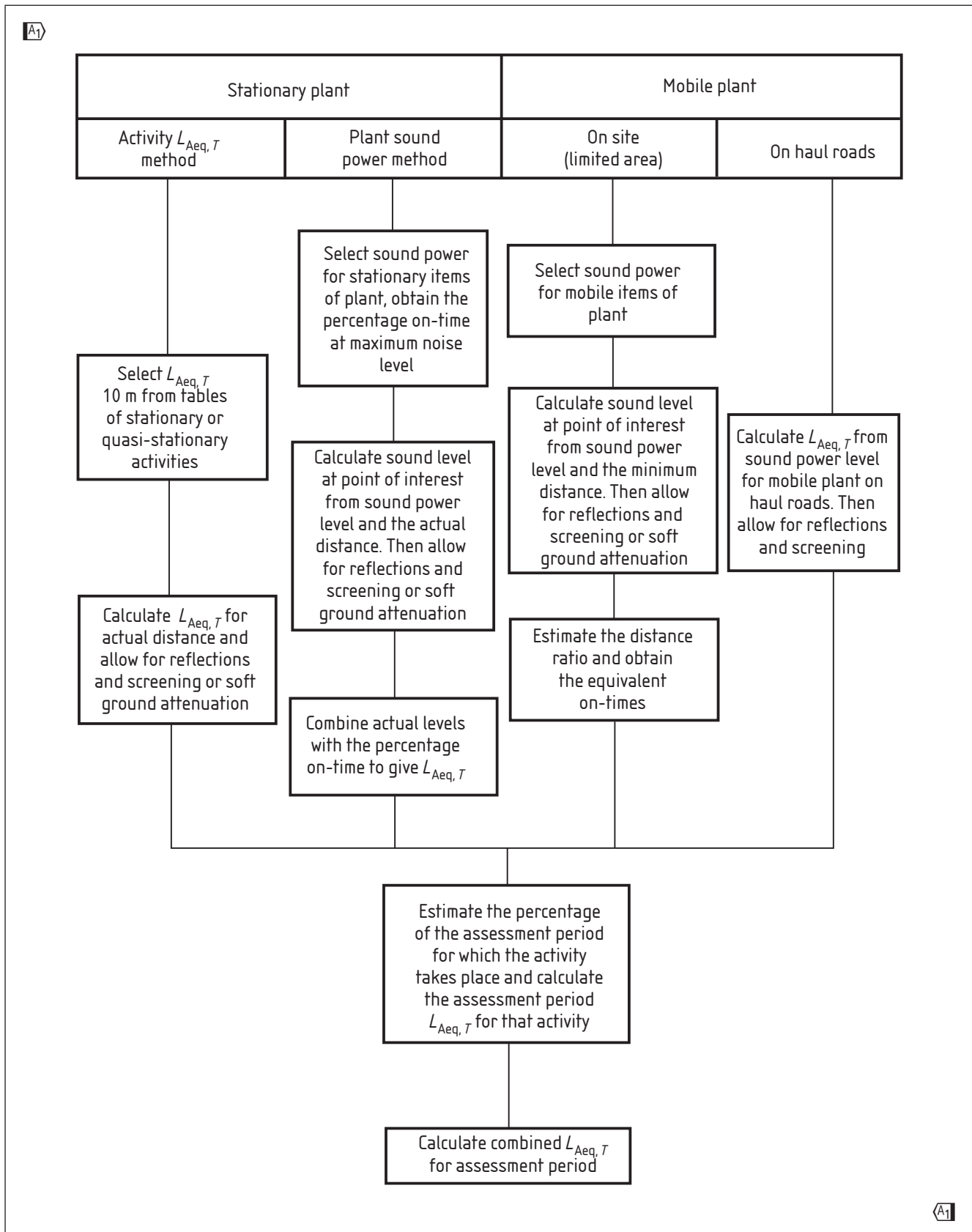

Licensed copy: WARRINGTON BOROUGH COUNCIL, 24/08/2018, Uncontrolled Copy, © BSI

F.2.2 Method for activity $L_{Aeq,T}$

F.2.2.1 General

The activity $L_{Aeq,T}$ method (see F.2.2.2) can be used for stationary and quasi-stationary activities and is the best method to use when these activities and their locations are clearly defined. Either measurements can be made on a similar item of plant operating in the relevant mode and power, or the values of $L_{Aeq,T}$ given in Annexes C and D can be used. The activity $L_{Aeq,T}$ needs to be corrected for source-receiver distance, reflections and screening or soft ground attenuation. The advantages of this method are that the variations in plant cycle times, interactions between various items of plant during the activity and the consequent overall variation of noise level with time are automatically taken into account. For continuous plant, it is necessary to determine the proportion of the assessment period during which the plant is operating and to adjust the $L_{Aeq,T}$ for periods of non-operation. For cyclic or intermittent plant, the number of complete sequences that will occur within the working day needs to be estimated and the $L_{Aeq,T}$ adjusted, if necessary, for standing or idling time. F.2.6 covers these allowances.

F.2.2.2 Method

F.2.2.2.1 Procedure

NOTE 1 Hard ground is taken to refer to ground surfaces which reflect sound, e.g. paved areas, rolled asphalt and surface water. Soft ground is taken to refer to surfaces which are absorbent to sound, e.g. grassland, cultivated fields or plantations. Where the ground cover between the source and the receiver is a combination of hard and soft, it is described as mixed.

NOTE 2 It is a matter of personal preference which method is used.

Account needs to be taken of the nature of the ground over which the sound is being propagated. The ground can be characterized as hard, soft or mixed (see Figure F.2 and F.2.2.2).

The procedure is as follows.

- a) *Stage 1.* Obtain an activity $L_{Aeq,T}$ by direct measurement of similar plant in the same mode of operation, or use the values given in Annexes C and D.
- b) *Stage 2.* If the distance R , in metres (m), from the point of interest to the geometric centre of the plant or activity is other than 10 m, subtract from the $L_{Aeq,T}$ obtained in stage 1 a distance adjustment K_h or K_s , in decibels (dB), obtained either:

- 1) from the following equations:

$$K_h = 20 \log_{10} \frac{R}{10} \quad (\text{F.1})$$

or

$$K_s = \left(25 \log_{10} \frac{R}{10} \right) - 2 \quad (\text{F.2})$$

where $R \geq 25$ m;

or

- 2) from Figure F.2, which is based on equations (F.1) and (F.2). Both methods give the same result.

- c) *Stage 3.* Make allowances for reflections and screening (see also 8.3.3, Figures F.2 and F.3 and Annex B).

The accurate determination of the effectiveness of a barrier is a complex process. A knowledge of sound pressure levels

at separate frequencies and also of the geometry of the receiving position in relation to the source and the barrier are required. Calculations may be made in octave bands instead of "A" weighting to provide a more accurate barrier attenuation; if the octave band sound levels (see Tables C.1 to C.11) and the positions of the sources, receiver and barrier are known. The barrier attenuation can be calculated from Figure F.3. The final results of this analysis then needs to be logarithmically summed and weighted to provide an "A" weighted level.

In the absence of spectral data, as a working approximation, if there is a barrier or other topographic feature between the source and the receiving position, assume an approximate attenuation of 5 dB when the top of the plant is just visible to the receiver over the noise barrier, and of 10 dB when the noise screen completely hides the sources from the receiver. High topographical features and specifically designed and positioned noise barriers could provide greater attenuation. Subtract the attenuation from the value of $\overline{A_1} L_{Aeq, T} \overline{A_1}$ calculated at the point of interest. Where the point of interest is 1 m from the façade of a building, make an allowance for reflection by adding 3 dB to the calculated (free field) levels.

- d) Stage 4. Repeat stages 1 to 3 for each activity.
- e) Stage 5. Estimate the percentage of the assessment period for which each activity takes place. Then use one of the methods outlined in F.2.6 to predict the assessment period $\overline{A_1} L_{Aeq, T} \overline{A_1}$ from the individual activity $\overline{A_1} L_{Aeq, T} \overline{A_1}$ values obtained in stage 3, which might be on a shorter time-base.

Figure F.2 Distance adjustment K for activity $\overline{A_1} L_{Aeq, T} \overline{A_1}$ method

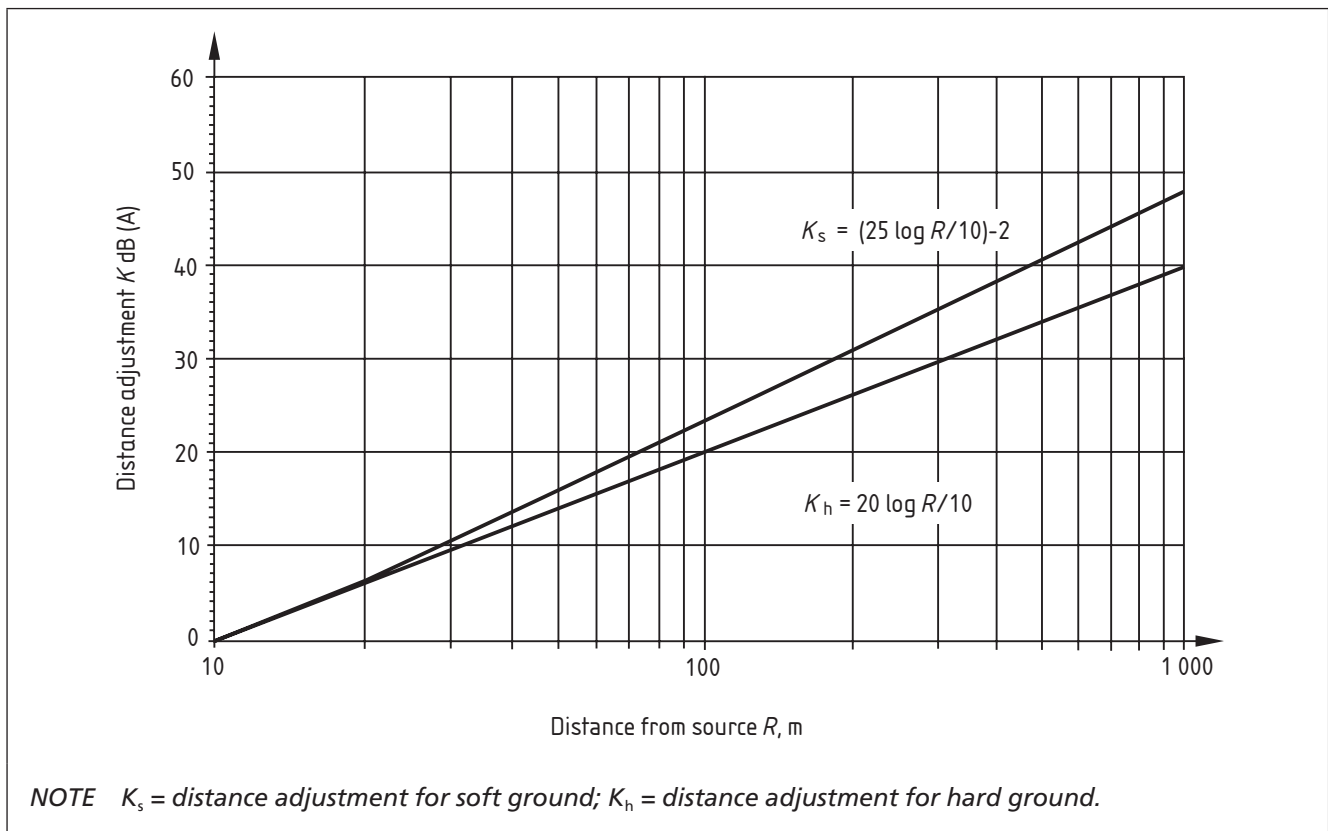
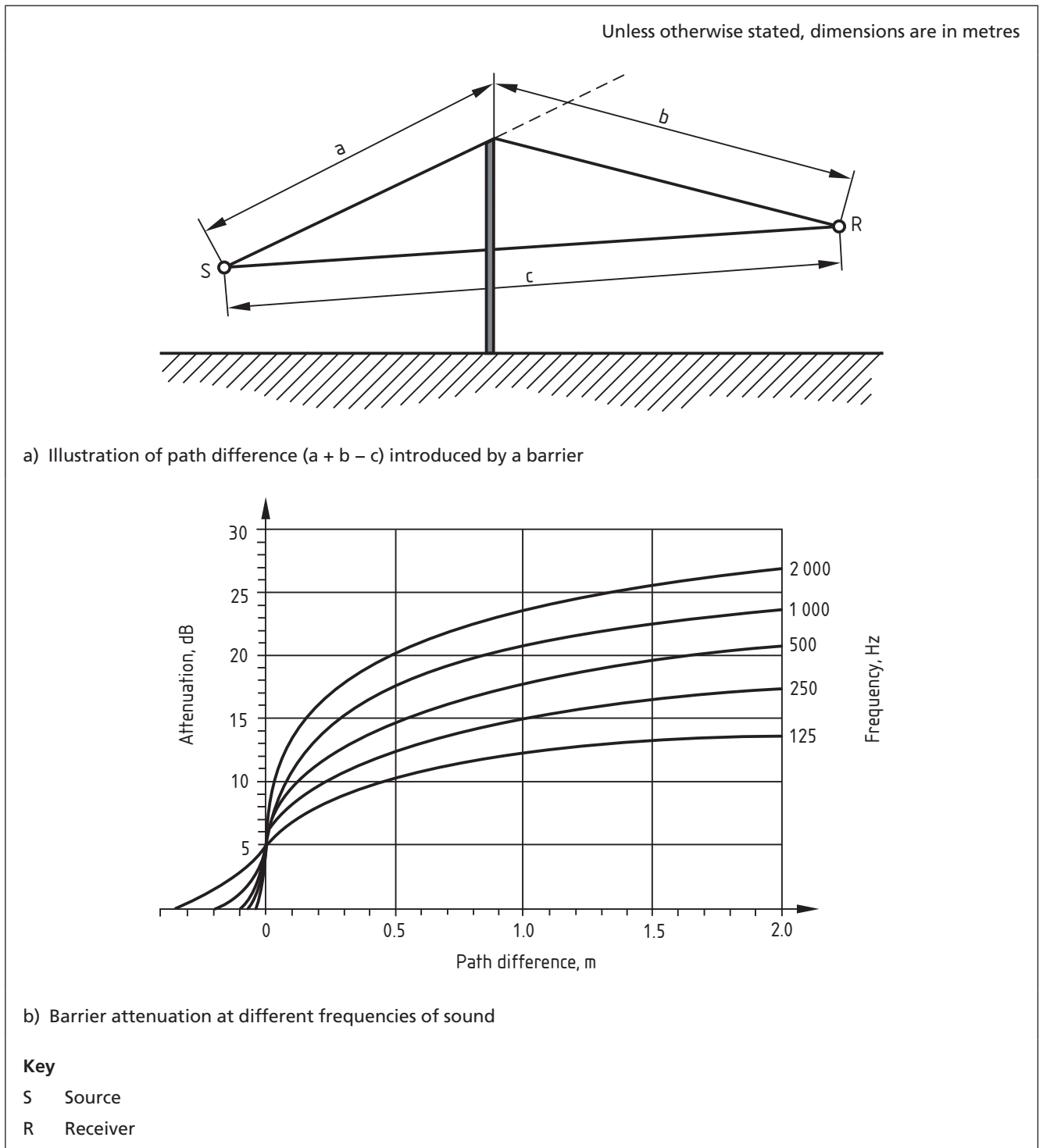

Figure F.3 Screening effect of barriers



F.2.2.2.2 Distance adjustment

For propagation over hard ground, $K = K_h$. For propagation over 100% soft ground, $K = K_s$, providing that the source is operating at ground level and the receiver is no more than 2.5 m above the ground. If either the source or receiver is more than 2.5 m above the ground, the additional attenuation offered by soft ground needs to be reduced until at 15 m its value is the same as that at hard ground.

For propagation over mixed soft and hard ground, the additional attenuation due to soft ground ($K_s - K_h$) needs to be reduced according to the proportion of soft ground [e.g. for 25% soft ground, the adjustment is $0.25(K_s - K_h)$].

Soft ground attenuation does not apply for propagation distances less than 25 m.

It is not usually advisable to combine the effects of screening and soft ground attenuation. Take either the attenuation from screening and hard ground propagation, or the attenuation of soft ground, whichever is the greater.

At distances over 300 m noise predictions have to be treated with caution, especially where a soft ground correction factor has been applied, because of the increasing importance of meteorological effects.

F.2.3 Method for plant sound power level

F.2.3.1 General

The plant sound power method (see F.2.3.2) can be used in the absence of sufficient data for the activity $L_{Aeq,T}^{(A)}$ method (see F.2.2) but it is necessary to know the on-time of the plant in order that comparable accuracy of site noise prediction can be obtained.

Where possible, the values given in Annex C are to be used as representative of operating plant. The sound power level values can be obtained by adding 28 dB(A) to the $L_{Aeq,T}^{(A)}$ values at 10 m distance. Alternatively, the values in Annex D could be used but these are of older plant and might provide a worst case. The third option is to use the maximum sound power levels of the plant permitted under EC Directive 2000/14/EC [11], as given in Table F.1.

The method involves the calculation of $L_{Aeq,T}^{(A)}$ from the plant sound power levels, typical percentage on-times and various allowances for distance, reflections, and screening or soft ground attenuation. Since this method necessitates the introduction into the calculation of the additional variable of percentage on-time, the method is more suitable for use in situations where an $L_{Aeq,T}^{(A)}$ for a similar activity is not available.

Neither this method nor the activity $L_{Aeq,T}^{(A)}$ method is suitable for predicting the $L_{Aeq,T}^{(A)}$ of mobile plant operating either on site in close proximity to the point of interest or on haul roads. Techniques for the estimation of noise of such mobile plant are given in F.2.4. The technique for plant operating over short traverses is similar to the sound power method but is modified for equivalent on-time related to traverse length and minimum distance to the point of interest.

F.2.3.2 Method**F.2.3.2.1 Procedure**

The procedure is defined below. However, if only the highest L_{pA} is required, stages 2 and 5 can be omitted.

- a) *Stage 1.* Select the sound power levels L_{WA} from measured data, Annexes C or D or Table F.1.
- b) *Stage 2.* Obtain the average percentage on-time from estimates of the time that the plant will be operating at full power.
- c) *Stage 3.* Calculate the sound levels, L_{pAr} at the point of interest for each item of plant or operation taking part in the activity, from their sound power levels and their distances, as follows. If the plant moves about a limited area on site, then take a time-weighted average distance to the point of interest.

Using the distance, R , in metres (m), from the point of interest to the source, calculate the sound level $\overline{L}_{Aeq,T}^{(A_1)}$ at the point of interest by subtracting from the sound power level L_{WA} obtained in stage 1 a distance allowance K' (in dB) obtained either:

- 1) from the following equations:

$$K_h' = (20 \log_{10} R) + 8 \quad (F.3)$$

or

$$K_s' = (25 \log_{10} R) + 1 \quad (F.4)$$

where $R \geq 25$ m;

or

- 2) from Figure F.4, which is based on equations (F.3) and (F.4).

- d) *Stage 4.* If necessary, adjust each sound level for reflections if the receiving position is 1 m from the façade of a building, i.e. apply a façade correction, and for screening, as detailed in stage 3 of **F.2.2.2.1**, adding or subtracting the allowances from the sound level L_{pA} obtained in stage 3 of the present procedure.
- e) *Stage 5.* Calculate the activity $\overline{L}_{Aeq,T}^{(A_1)}$ at the point of interest for the period of that activity by subtracting from the modified L_{pA} obtained in stage 4 the adjustment K_T obtained from Figure F.5 for the on-time obtained in stage 2.
- f) *Stage 6.* Repeat stages 1 to 5 for each activity.
- g) *Stage 7.* Estimate the percentage of the assessment period for which each activity takes place, then use one of the methods outlined in **F.2.6** to predict the assessment period $\overline{L}_{Aeq,T}^{(A_1)}$ from the individual activity $\overline{L}_{Aeq,T}^{(A_1)}$ values calculated in stage 5, which may be on a shorter time-base.

NOTE 1 In practice, sources of noise such as construction site equipment do not radiate sound uniformly in all directions. Equations (F.3) and (F.4) can be adapted to allow for this directivity effect and for reflections within the site. However, for the purposes of calculations in this standard the effect is ignored.

NOTE 2 The sound level can be calculated for various conditions of operation, such as working and idling, using either of the two methods.

Figure F.4 Distance adjustment K' for plant sound power method

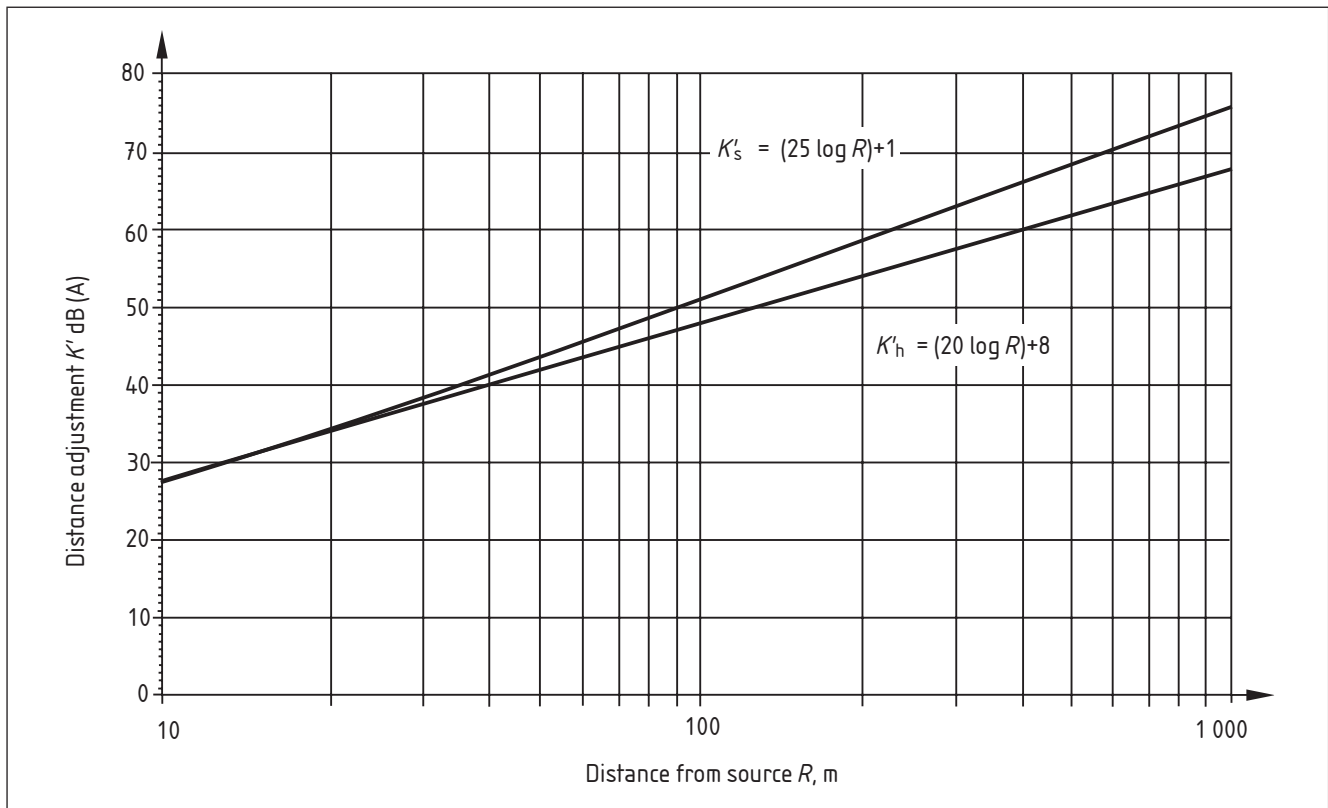
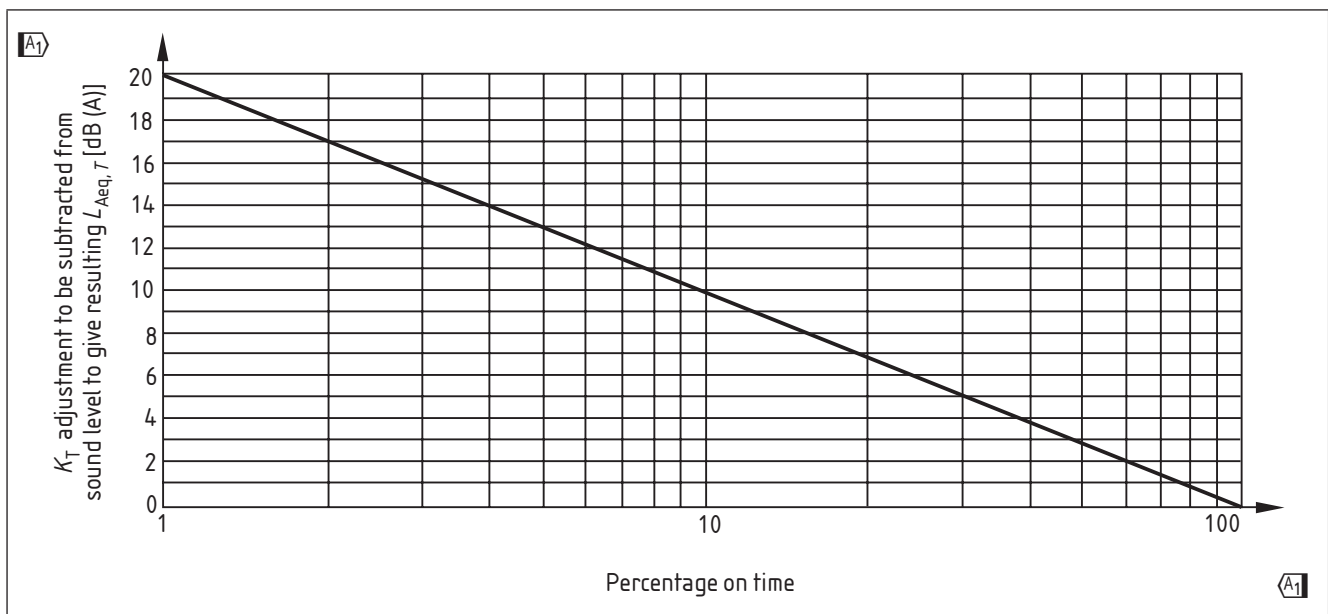

Figure F.5 Adjustment to sound level to give resulting $L_{Aeq,T}$ (plant sound power method)



F.2.3.2.2 Distance adjustment

For propagation over hard ground, $K' = K'_h$. For propagation over 100% soft ground, $K' = K'_s$, providing that the source is operating at ground level and the receiver is no more than 2.5 m above the ground. If either the source or receiver is more than 2.5 m above the ground, the additional attenuation offered by soft ground needs to be reduced until at 15 m its value is the same as that at hard ground.

For propagation over mixed soft and hard ground, the soft ground attenuation ($K_s' - K_h'$) needs to be reduced according to the proportion of soft ground [e.g. for 25% soft ground, the adjustment will be $0.25(K_s' - K_h')$]. Soft ground attenuation does not apply for propagation distances less than 25 m. Either the attenuation from screening and hard ground propagation, or the attenuation of soft ground needs to be taken.

It is not usually advisable to combine the effects of screening and soft ground attenuation. At distances over 300 m, caution is needed, especially on applying the soft ground curves, because of the increasing importance of meteorological effects.

F.2.4 Method for mobile plant in a defined area

F.2.4.1 General

The prediction of the $L_{Aeq,T}^{(A_1)}$ from mobile plant operating over a small area or on site (see F.2.4.2) can be used for other activities when items of mobile plant are operating in close proximity to the point of interest, taking into account the adjustment of the predicted $L_{Aeq,T}^{(A_1)}$ for standing and idling time of the plant.

F.2.4.2 Method

The procedure for fixed plant in F.2.2 and F.2.3 can be used.

Estimates of the $L_{Aeq,T}^{(A_1)}$ from mobile plant working in a limited area made using the methods described in F.2.2 or F.2.3 tend to err on the high side because the orientation of the plant varies relative to the point of interest. The errors for estimates of sound level at some distance from the site can be neglected, but when the point of interest is close to the site, i.e. the traverse length is greater than half of the minimum distance to the point of interest, a further refinement is necessary to minimize errors.

To estimate the noise level of slow moving plant (typically of speeds from 5 km/h to 10 km/h) working over short traverses, the following procedure can be adopted.

- a) *Stage 1.* Select the sound power level given in Table F.1 or Annexes C and D.
- b) *Stage 2.* Calculate the sound level at the receiving position for the plant from the sound power level when the plant is at its closest proximity to the receiving position, as detailed in stage 3 of F.2.3.2.1.
- c) *Stage 3.* If necessary, make allowances for reflections if the receiving position is 1 m from the façade of a building and for screening as detailed in stage 3 of F.2.2.2.1, adding or subtracting the allowances from the sound level $L_{Aeq,T}^{(A_1)}$.
- d) *Stage 4.* Estimate the distance ratio (traverse length/minimum distance to receiving position) and obtain the equivalent on-time from Table F.2.
- e) *Stage 5.* Estimate the percentage of the assessment period for which the activity takes place. Then correct the on-time for the period of the activity using equation (F.5) (see stage 6).

- f) *Stage 6.* Repeat stages 1 to 5 for each activity of this type where:

$$t_c = T_t \times F \quad (\text{F.5})$$

where:

t_c is the corrected on-time;

T_t is the total time for which the plant is likely to work during the period of interest;

F is the on-time correction factor.

- g) *Stage 7.* Use one of the methods outlined in F.2.6 to predict the assessment period $\overline{L_{Aeq,T}}_{A1}$ from the sound level L_{pA} and the corrected on-times.

F.2.5 Method for mobile plant using a regular well-defined route (e.g. haul roads)

F.2.5.1 General

The prediction of $\overline{L_{Aeq,T}}_{A1}$ from mobile plant using a regular route (see F.2.5.2) can be used when items of mobile plant pass at a known rate per hour.

In the absence of data measured directly for items of plant to be used on the site under assessment, the sound power levels stated in EC Directive 2000/14/EC [11] (see Table F.1) or the values given in Annexes C and D can be used.

F.2.5.2 Method

For mobile items of plant that pass at intervals (such as earth-moving machinery passing along a haul road), it is possible to predict an equivalent continuous sound level using the following method.

- a) *Stage 1.* The general expression for predicting the $\overline{L_{Aeq,T}}_{A1}$ alongside a haul road used by single engined items of mobile plant is:

$$\overline{L_{Aeq,T}}_{A1} = L_{WA} - 33 + 10\log_{10}Q - 10\log_{10}V - 10\log_{10}d \quad (\text{F.6})$$

where:

L_{WA} is the sound power level of the plant, in decibels (dB);

Q is the number of vehicles per hour;

V is the average vehicle speed, in kilometres per hour (km/h);

d is the distance of receiving position from the centre of haul road, in metres (m).

Estimates of the $\overline{L_{Aeq,T}}_{A1}$ from a haul road used by other types of mobile plant with twin engines can be made by adding a further 3 dB(A) to the $\overline{L_{Aeq,T}}_{A1}$ calculated using equation (F.6).

- b) *Stage 2.* If necessary, adjust the equivalent sound level for reflections (if the receiving position is 1 m from a building façade) and for screening (as detailed in stage 3 of F.2.2.2.1), adding or subtracting the allowances from the $\overline{L_{Aeq,T}}_{A1}$ obtained in stage 1 of the present procedure.
- c) *Stage 3.* Where the angle of view, a_v (in degrees), of the haul road is less than 180°, apply an angle of view correction A , where:

$$A = 10\log(a_v/180) \quad (\text{F.7})$$

- d) *Stage 4.* Repeat stages 2 and 3 for each activity.
- e) *Stage 5.* Estimate the percentage of the assessment period for which each activity takes place, then use one of the methods outlined in F.2.6 to predict the assessment period $\overline{L_{Aeq,T}^{(A_1)}}$ from the individual activity $\overline{L_{Aeq,T}^{(A_1)}}$ values obtained in stage 4, which might be on a shorter time-base than the assessment period.

F.2.6 Summation of sound levels

F.2.6.1 Conditions constant

When conditions on site are such that all activities affecting the noise level at the point of interest are carried out continuously for any assessment period, the activity $\overline{L_{Aeq,T}^{(A_1)}}$ values obtained from F.2.2, F.2.3, F.2.4 and/or F.2.5 can be combined in the same way as actual continuous sound levels. It is possible to combine the separate sound levels in pairs. This is done by obtaining the difference between them and adding a correction to the higher level; approximate corrections are given in Table F.3. For a number of activities, this process can be repeated by combining two levels at a time until a single value is obtained, starting with the lowest pair of levels and working upwards in sequence.

Table F.3 Addition of steady sound levels

Difference between the two levels dB(A)	Addition to the higher level dB(A)
0	3
1	3
2	2
3	2
4	1
5	1
6	1
7	1
8	1
9	1
10 and over	0

The generalized formula for the combination of two sound levels dB_1 and dB_2 is:

$$dB_{\text{Total}} = 10 \log_{10} \left(10^{\frac{(dB_1)}{10}} + 10^{\frac{(dB_2)}{10}} \right) \quad (\text{F.8})$$

As this method is used when the activity $\overline{L_{Aeq,T}^{(A_1)}}$ values are appropriate for a complete assessment period, the calculated sound level will be the combined equivalent continuous sound level $\overline{L_{Aeq,T}^{(A_1)}}$ for that period only. For other periods it is necessary to use the method described in F.2.6.2.

F.2.6.2 Conditions varying during the assessment period

When conditions on site are such that some or all of the activities affecting the noise level at the point of interest continue for less than the assessment period, the values of $L_{Aeq, T}^{(A)}$ obtained from F.2.2, F.2.3, F.2.4 and/or F.2.5 may be combined as in equation (F.9).

$$L_{Aeq, T} = 10 \log 10 \frac{1}{T} \sum_{i=1}^n t_i 10^{0.1L_i} \quad (F.9)$$

where:

$L_{Aeq, T}^{(A)}$ is the combined equivalent continuous A-weighted sound pressure level, in decibels (dB), over a given period T ;

L_i is the individual equivalent continuous A-weighted sound pressure level, $L_{Aeq, T}^{(A)}$, for an item of plant or activity during a period t_i , in decibels (dB);

n is the total number of individual equivalent continuous A-weighted sound pressure levels to be combined.

F.2.7 Example calculations

F.2.7.1 Example 1 – Building, office development

F.2.7.1.1 General

This example is based on Figure F.6.

Excavations are in progress for foundations of an office block, including breaking out of some old concrete bases, at a site next to existing offices. A tracked excavator (95 kW) is digging out spoil, placing it on a temporary tip which partially screens the machine from the offices. A wheeled loader (75 kW) is backfilling part of the excavated area with spoil from a nearby pile. Two hand-held breakers are being used to break out old concrete and are powered from a sound-proofed compressor.

During the working day the plant is in use for the following periods:

- a) excavator: 8 h;
- b) loader: 4 h;
- c) breakers: 3 h.

The example predicts the 10 h $L_{Aeq, T}^{(A)}$ at the façade of the office nearest to the site activities.

Consider the plant that is operating and select the methods to be used for the plant types. The excavator, compressor and breakers can be treated by the activity $L_{Aeq, T}^{(A)}$ method (see F.2.2) whereas the wheeled loader which is mobile in operation has to be treated by the method for mobile plant on site (see F.2.4).

The example calculations are shown in Tables F.4 and F.5, and described in F.2.7.1.2 and F.2.7.1.3.

Figure F.6 Office development site showing plant locations in relation to the nearest affected façade

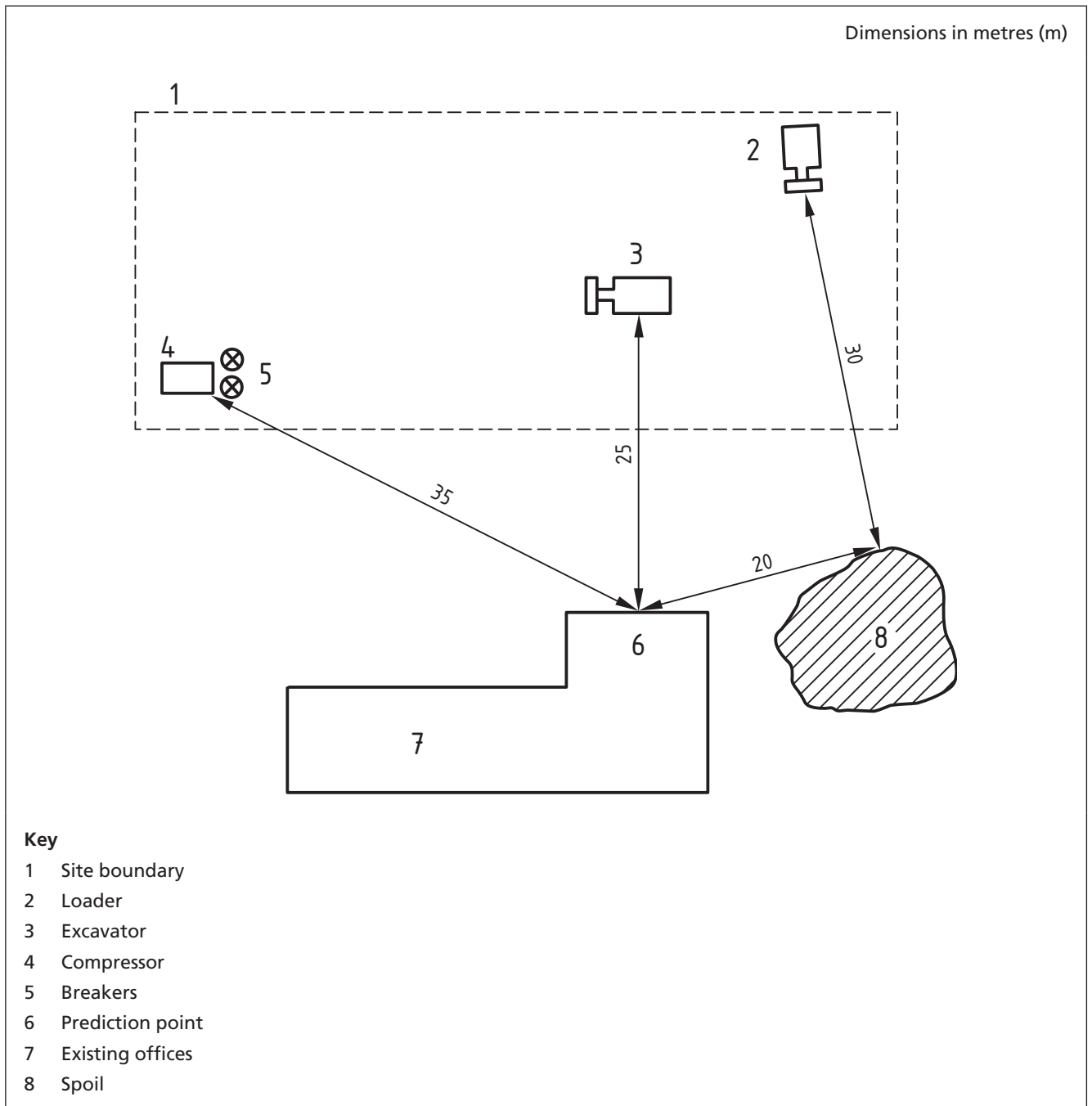

Licensed copy: WARRINGTON BOROUGH COUNCIL, 24/08/2018, Uncontrolled Copy, © BSI

Table F.4 Example of prediction of noise from stationary plant

Plant type	$L_{Aeq,T}$ at 10 m dB	Distance		Adjustments		Resultant $L_{Aeq,T}$ dB	Duration of activity h	Duration of activity as percentage of 10 h %	Correction to $L_{Aeq(10h)}$ dB	Activity $L_{Aeq(10h)}$ dB
		m	Step 3	Step 4	Step 5					
Excavator	71	25	-8	-5	+3	61	8	80	-1	60
Compressor	65	35	-11	0	+3	57	3	30	-5	52
Breaker	83	35	-11	0	+3	75	3	30	-5	70
Breaker	83	35	-11	0	+3	75	3	30	-5	70

Table F.5 Example of prediction of noise from mobile plant

Plant type	Average L_{WA} dB	Distance		Adjustments		Resultant L_{pA} dB	Equivalent on-time h	Correct percentage on-time %	Correction to $L_{Aeq(10h)}$ dB	Activity $L_{Aeq(10h)}$ dB		
		m	Step 3	Step 4	Step 5						Step 6	Step 7
Loader	99	20	-34	0	+3	68	30/20 = 1.5	0.5	4	20	-7	61

F.2.7.1.2 Activity L_{Aeq} method

Calculate the estimated noise using the method described in **F.2.2** as follows.

NOTE Step numbers refer to Table F.4.

- a) Tabulate the activities of items of plant (step 1).
- b) Select the $L_{Aeq, T}(\overline{A_1})$ at 10 m from the item of plant or activity (step 2). Use measured values of activity $L_{Aeq, T}(\overline{A_1})$ for the same plant in the same mode of operation, or use the values in the following tables: for the excavator see Table C.4, reference number 5; for the compressor see Table C.5, reference number 5 and for the two breakers see Table C.1, reference number 6.
- c) Take the distance from the drawing of the plant or activity to the point of interest (step 3) and obtain the corresponding allowance, in decibels, from Figure F.2 (step 4).
- d) Include allowances for screening (step 5) and reflections (step 6) from which the $L_{Aeq, T}(\overline{A_1})$ of each activity is obtained (step 7).
- e) Then tabulate the duration of each activity, in hours, as the percentage of the 10 h period (steps 8 and 9) and use with each activity $L_{Aeq, T}(\overline{A_1})$ to obtain a correction to $L_{Aeq(10h)}$ from Figure F.5 (step 10).
- f) Add the correction to $L_{Aeq(10h)}$ to the resultant $L_{Aeq, T}(\overline{A_1})$ to obtain the activity $L_{Aeq(10h)}$ (step 11).

F.2.7.1.3 Mobile plant on site

Calculate the estimated noise using the method described in **F.2.4** as follows.

NOTE Step numbers refer to Table F.5.

- a) Tabulate the item of plant (step 1).
- b) Select the sound power level L_{WA} for the item of plant (step 2). For the loader refer to Table B.4, reference number 13, or take the EC limit of 103 dB for L_{WA} from Table F.1.
- c) Take the distance from the drawing of the plant from the point of interest (step 3) and the corresponding adjustments to correct to sound level at that distance from Figure F.4 (step 4).
- d) Include allowances for screening (step 5) and reflections (step 6) from which the resultant sound level can be calculated (step 7).
- e) Estimate the distance ratio, traverse length/minimum distance ($30/20 = 1.5$) (step 8) and obtain the equivalent on-time from Table F.2 (step 9).
- f) Use the equivalent on-time, duration of activity (step 10) and equation (F.5) to obtain the corrected on-time (step 11).
- g) Use the corrected on-time as a percentage of 10 h period (step 11) and the resultant sound level (step 7) to obtain the correction to $L_{Aeq(10 h)}$ from Figure F.5 (step 12).
- h) Add the correction to $L_{Aeq(10 h)}$ to the resultant L_{pA} to obtain the activity $L_{Aeq(10 h)}$ (step 13).

F.2.7.1.4 Resultant noise level

The $L_{Aeq(10 h)}$ values from all the activities, the activity $L_{Aeq, T}(\overline{A_1})$ and mobile plant on site methods are added together using Table E3. The addition of noise levels 60 dB, 52 dB, 70 dB, 70 dB and 61 dB gives a combined $L_{Aeq(10 h)}$ level of 74 dB to the nearest whole number.

F.2.7.2 Example 2 – Civil engineering: spoil movement on a haul road

F.2.7.2.1 General

This example is based on Figure F.7.

Spoil is being taken from civil engineering works along a haul road which passes 50 m from a farm house across substantially hard ground. The loads are carried in articulated dump trucks (190 kW). The condition of the haul road is maintained by a grader (205 kW). Details of the journeys made are as follows.

- a) dump trucks: 12 journeys each way per hour at 25 km/h;
- b) grader: one journey each way per hour at 7 km/h.

Operations are continuous for the 12 h day. The angle of view of the haul road is 180°. The method to be adopted for predicting the noise is that for mobile plant on haul roads (see F.2.5). The prediction method is based on equation (F.6).

Figure F.7 Spoil movement on a haul road showing location of the nearest affected property

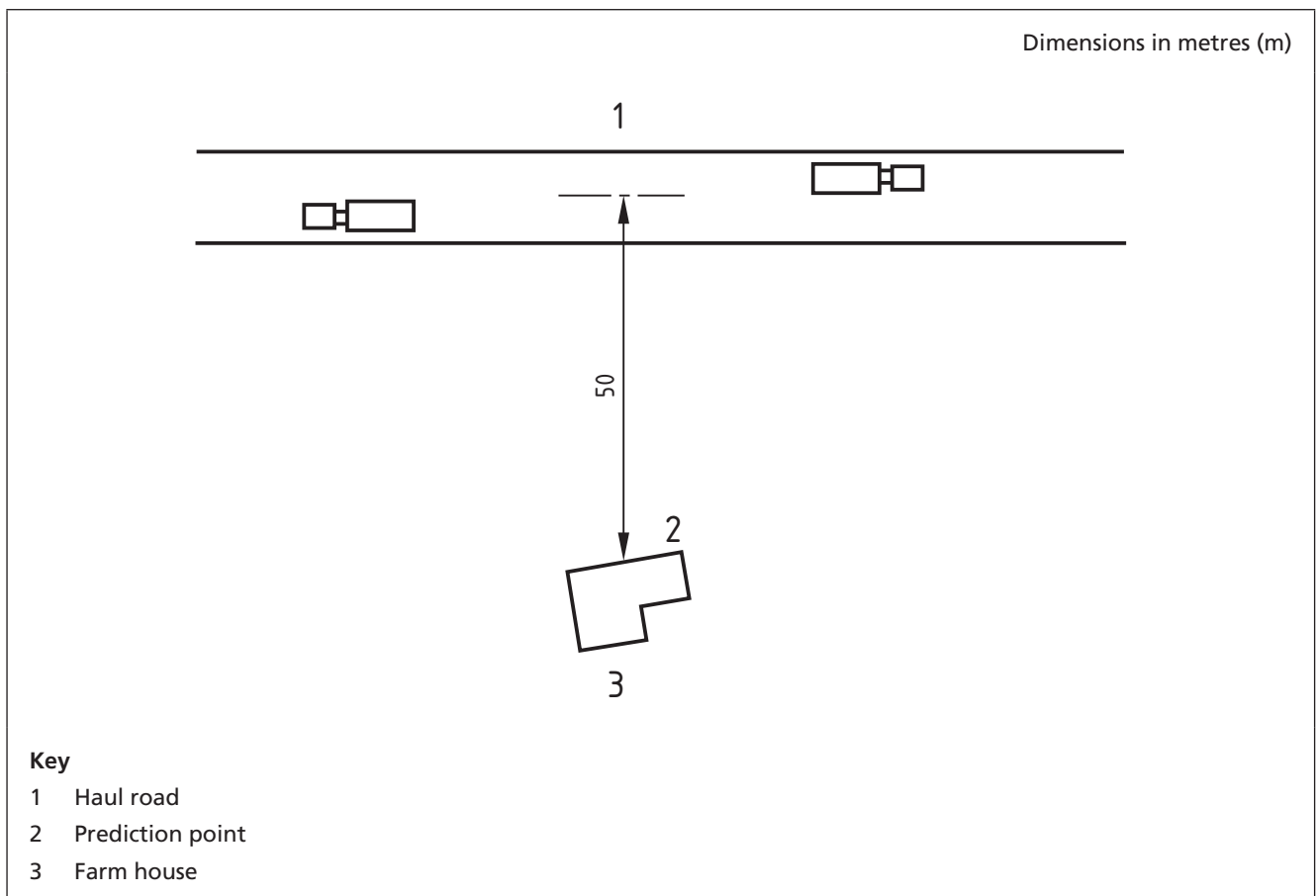

F.2.7.2.2 Sound level of plant

Calculate the sound level as follows.

- a) *Dump trucks*. Assume an average sound power level for trucks travelling at similar speed. Refer to Table C.4, reference numbers 1 and 2, and Table C.5, reference numbers 16 and 17.

$$\text{Average } L_{WA} = 108 \text{ dB}$$

Using equation (F.6) and substituting for $Q = 24$ (12 return journeys), $V = 25$ km/h and $d = 50$ m, then:

$$L_{Aeq(1 \text{ h})} = 58 \text{ dB}$$

- b) *Grader*. Select the sound power level from the tables. Refer to Table C.5, reference numbers 14 and 15 and Table C.6, reference number 31.

$$\text{Average } L_{WA} = 113 \text{ dB}$$

Using equation (F.6) and substituting for $Q = 2$ (one return journey), $V = 7$ km/h and $d = 50$ m, then:

$$L_{Aeq(1 \text{ h})} = 58 \text{ dB}$$

F.2.7.2.3 Resultant noise level

The total $L_{Aeq, T}$ from the two types of plant is obtained by combining these levels using Table F.3 as follows.

Combine 58 dB with 58 dB: the difference is 0 dB so add 3 dB = 61 dB.

As the point of interest is at the building façade, an allowance for reflections of +3 dB is made; there is no allowance for screening as there is direct line of sight.

As operations are continuous over the 12 h day there is no correction necessary for duration of activity.

Hence the resultant façade level:

$$L_{Aeq(12 \text{ h})} = 61 + 3 = 64 \text{ dB}$$

Annex G (normative) Noise monitoring

COMMENTARY ON ANNEX G

This annex gives guidance on the monitoring of noise from sites for the purposes of assessing compliance with noise control targets. Only noise affecting the neighbourhood, i.e. the area around the site, is considered. The need for, and the frequency of, monitoring will be determined by the specific circumstances of the site.

NOTE The monitoring of occupational noise within the working area of the site is covered under the Control of Noise at Work Regulations 2005 [2].

G.1 Instrumentation

[A1] The instrumentation system should be designed to determine equivalent continuous A-weighted sound pressure level (see 3.7). The instrumentation should conform to the requirements for integrating averaging sound level meters, preferably of type 1 as specified in BS 7580-1:1997, but at least of type 2 as specified in BS 7580-2:1997, with verification of conformity being undertaken by periodic testing in accordance with these standards. Alternatively, instrumentation conforming to BS EN 61672-1:2013, preferably of class 1, but at least of class 2, should be used and should be periodically tested in accordance with BS EN 61672-3:2013. Alternative instrumentation, if used, should provide equivalent performance in respect of frequency and time weightings and tolerances.

NOTE 1 BS EN 61672-1:2013, which superseded BS EN 61672-1:2003, is the current British Standard specification for integrating averaging sound level meters, BS EN 61672-1:2003 having superseded BS EN 60804:2001, which in turn superseded BS EN 60804:1994. However, many meters conforming to BS EN 60804:1994 remain in use and are regarded as acceptable for the purposes of this British Standard. BS 7580-1:1997 and BS 7580-2:1997, which specify the test procedures for the verification of conformity to the requirements given in BS EN 60804:1994 for type 1 and type 2 meters respectively, remain current.

NOTE 2 Users of this part of BS 5228 are advised to consider the desirability of having meters tested periodically, for verification purposes, by a test laboratory that is accredited to BS EN ISO/IEC 17025 by a national or international accreditation body.

Manufacturers' instructions that accompany measuring instruments should be followed strictly. Every precaution should be taken before use to ensure that the instruments are accurately calibrated and, in the case of battery-operated instruments, that the batteries have not run down. A sound calibrator or pistonphone, preferably one conforming to BS EN 60942:2003, class 1, should be used to check the correct operation of the meter.

In addition to the periodic testing recommended in the first paragraph, sound calibrators should be used whenever monitoring takes place; typically before and after each measurement session.

*NOTE 3 BS EN 60942:2003 is the current British Standard for sound calibrators. Sound level meters conforming to BS EN 60804:1994 might have been supplied with sound calibrators conforming to BS 7189:1989 (identical with IEC 942:1988) which was superseded by BS EN 60942:1998. **[A1]***

G.2 Measurement methods

G.2.1 General

Various alternative methods of noise measurement are described in this annex. The method to be selected in a particular case will depend on the temporal variations of noise level, on the resources available, on the location and on the time period over which the noise is to be measured.

Precautions should be taken to ensure that measurements are not affected by the presence of measurement personnel, by wind or other extraneous sources such as electric fields. If it is known that a measured sound level has been affected, the factors involved should be noted at the same time as the sound level. In some situations it is possible to correct the measured noise level for the effects of extraneous noise. When such a correction is made, it should be noted and the possible effects on measurement accuracy should be borne in mind.

When carrying out source noise measurements, research [62] has shown that the largest error is likely to be due to inaccuracies in the estimation of the distance from the source to the microphone. As error of 10% is likely to result in an error of 0.8 dB, consequently it is recommended that to maintain precision, the perpendicular source to receiver distance be determined with the greatest possible accuracy.

G.2.2 Sampling methods

Representative construction noise levels can be obtained in a variety of ways when the testing of compliance with noise control targets or limits is necessary. The most robust method is to permanently monitor construction noise levels at fixed locations and these can then be routinely checked against the stated limits on a day to day basis. However, this is not always either necessary or practicable and sampling techniques can be used to estimate the $L_{Aeq,T}^{(A)}$ over similar periods.

Sampling techniques can be divided into the following two broad categories.

- a) *Regular sampling throughout the whole period* (e.g. 5 min/h over the working period). This procedure still requires the presence of staff and instrumentation during the full working period but permits measurements to be undertaken at several locations.
- b) *A single sample*. This procedure is useful when it is only possible to visit the site for a limited period. The reliability of this technique can be improved by avoiding periods when the site is not operating normally (e.g. meal breaks). However, if adopting this technique, then it is critical that the activity occurring during the monitoring is similar to that which would occur for the full period.

The size of possible errors in estimates of $L_{Aeq,T}^{(A)}$ values obtained by sampling will depend on the type of sampling technique adopted, the length of time for which the noise is sampled and the pattern of noise emitted by the site.

Table G.1 provides some guidance on typical ranges of errors likely to be encountered when various sampling strategies are used. The figures quoted in the table are based on measurements at a number of construction sites but might not be applicable for large sites where there are very wide fluctuations in noise level or activity (e.g. for some types of piling).

Table G.1 Estimation of daily $L_{Aeq,T}$ according to sampling technique

Sampling technique	Daily $L_{Aeq,T}$ estimated within 95% confidence dB
5 min every 1 h	± 2.5
20 min every 1 h	± 1.5
Single 20 min sample	$\pm 5^A$
Single 60 min sample	$\pm 3^A$

^{A)} These figures assume that measurements are taken only when the site is working normally (e.g. not during meal breaks).

G.3 Monitoring of L_{Amax} and $L_{A01,T}$

As noted in 6.2, the measurements of L_{Amax} and $L_{A01,T}$ are useful for rating the noise from isolated events which might not always be apparent from a longer period $L_{Aeq,T}$. As with $L_{Aeq,T}$, various methods are available including the use of automatic, unattended equipment. However, these measures are particularly susceptible to extraneous unwanted noises. When, therefore, the object of the measurements is to assess compliance with noise control targets, measurement data from unattended equipment should be used with caution.

L_{Amax} and $L_{A01,T}$ should be measured using a sound level meter using the fast time weighting.

G.4 Information to be recorded

The following information should be recorded:

- the measured values of $L_{Aeq,T}$ and, where appropriate, L_{Amax} or $L_{A01,T}$, together with details of the appropriate time periods;
- details of the instrumentation and measurement methods used, including details of any sampling techniques, position of microphone(s) in relation to the site and system calibration data;
- any factors that might have adversely affected the reliability or accuracy of the measurements;
- plans of the site and neighbourhood showing the position of plant, associated buildings and notes of site activities during monitoring period(s);
- notes on weather conditions, including where relevant, wind speed/direction, temperature, presence of precipitation, etc.;
- time, date and name of person carrying out the measurement.

Annex H (informative) Types of piling

H.1 General

Piles can be divided into two main categories: bearing piles and embedded retaining wall piles. It is possible in principle to install either category by driving, pressing or boring (see Figure H.1). Ground or other site conditions can, however, prohibit the use of one or other of these techniques, which are described in more detail in H.2 to H.4.

There are other methods of forming medium to deep foundations under certain conditions. These include the installation of stone columns by vibroreplacement (see H.5), deep compaction by dynamic consolidation (see H.6), and diaphragm walling (see H.7). Although the mechanical plant and equipment can differ in some ways from those used in conventional piling, the problems of protecting the neighbourhood from noise disturbance are similar.

H.2 Driven piles

NOTE See 8.5.1 for guidance on control of impact-driven piles.

In conventional driven piling, a hammer is used to strike the top of the pile via a helmet and/or a sacrificial dolly. High peak noise levels will arise as a result of the impact. The hammer can be a simple drop hammer or it can be actuated by steam, air, hydraulic or diesel propulsion. Displacement piles can be top-driven, bottom-driven or can be driven by means of a mandrel.

In certain ground conditions it might be possible to drive piles using a vibratory pile driver, in which cases high impact noise might not arise, but the continuous forced vibration together with structure-borne noise can give rise to some disturbance.

Enlarged pile heads are sometimes formed for compression piles beneath a reinforced embankment or a concrete slab. Installation of the temporary former can give rise to some disturbance.

When piles are driven for temporary works, further disturbance can occur if the piles are extracted at a later date.

H.3 Pressed-in piles

A method for installing either retaining or bearing steel piles without either hammering or vibratory driving is by pressing. One or a pair of piles is pushed into the ground using the reaction of a group of several more adjacent piles. The main source of noise is the engine driving the hydraulic power pack for the pressing system. Other sources of noise include cranes and ancillary equipment.

To aid pile installation, pre-boring and/or water jetting can be used.

Figure H.1 Piling and kindred ground treatment systems

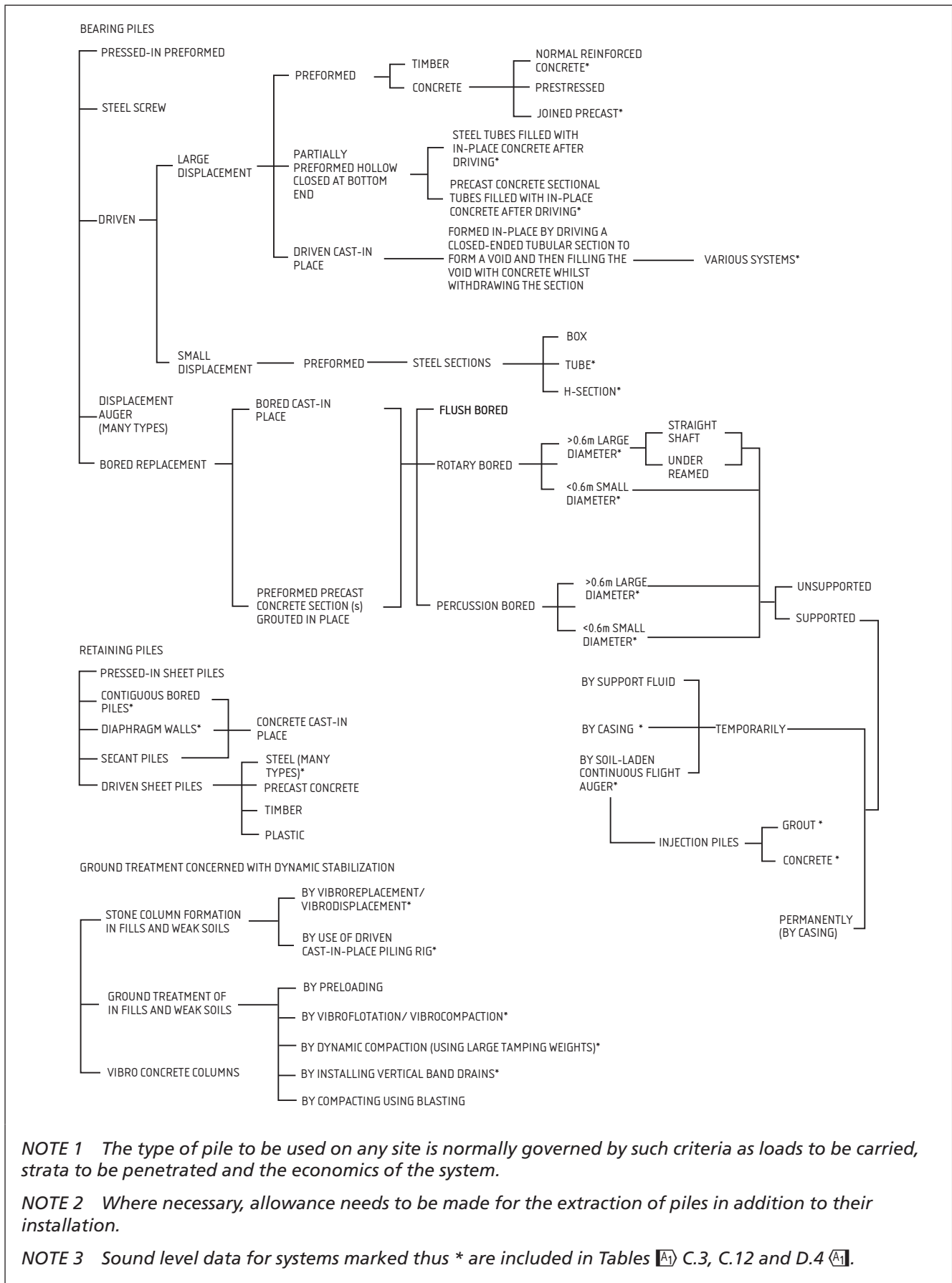

H.4 Bored piles

Bored piles can be constructed by means of a rotary piling rig or by impact boring. In the former case the major source of noise is the more or less steady noise of the engine that supplies the power to perform the drilling. In some soils it is necessary to insert steel casings for part of the depth. If the casings have to be driven in and/or extracted by hammering, high peak noise levels will result. Similar considerations apply to the impact boring technique. The noise characteristics are therefore likely to be at a relatively steady and continuous level with intermittent high peaks superimposed upon it.

Bored piling sites frequently need much ancillary equipment including support fluid preparation and reclamation plant, reinforcing cage manufacturing plant, pumps and handling cranes. The layout of plant on the site is important for efficient operation and can exert considerable influence on noise control. The support fluid, which might be water, polymer or a bentonite suspension, can be used to provide bore stability, and all ancillary plant associated with this needs to be taken into account in the noise assessment.

Coring through existing piles and foundations is becoming more common on urban sites. Noise resulting from this process will need to be assessed and other foundation solutions considered such as the re-use of piles or foundations.

A method for boring piles that does not need a temporary casing is the use of a continuous flight auger and the injection of concrete or grout to form the piles. It might not be applicable in some ground conditions, and the range of pile diameters and depths is limited. However, this is the most used piling method in the UK. Enlarged pile heads are sometimes formed for compression piles beneath a reinforced embankment or a concrete slab. Installation of the temporary former can give rise to some disturbance.

Proprietary displacement auger piling methods are available which produce little or no spoil.

H.5 Vibroflotation/vibrocompaction and vibroreplacement/vibrodisplacement

A method for improving the bearing capacity of weak soils and fills is to use a large vibrating poker which can be mounted on a crane or an excavator base. In loose cohesionless soils the vibrations cause compaction to a denser state; this process is known as vibroflotation or vibrocompaction. In other weak soils a vibrating poker is used to form a hole which is then backfilled with graded stone and compacted by the poker; this process is known as vibroreplacement or vibrodisplacement. Water or compressed air can be used as a jetting and flushing medium.

Vibro concrete columns (VCC) are backfilled with concrete instead of graded stone.

Typically, vibrating pokers are actuated by electric or hydraulic motors. To reduce the noise of the operation, attention needs to be paid to the generator or power pack as appropriate. Other sources of noise could include pumps when using water flush, or air escaping from the poker when this is exposed.

H.6 Deep compaction by dynamic consolidation

An alternative method for improving the bearing capacity of weak soils and fills is to drop a large tamping weight from a height on to the ground at selected locations. Typically in the UK, tamping weights between 10 t and 20 t are used and are dropped from heights between 10 m and 25 m. The tamping weight is normally raised by and dropped from a very large crawler crane and the noise characteristic contains both steady (crane engine) and impulsive (impact of weight on ground) components.

H.7 Diaphragm walling

Diaphragm walling can be used when deep foundation elements are needed with both retaining and bearing capabilities. The soil is excavated in a trench under a thixotropic bentonite suspension in a series of panels, usually using a special clamshell grab; when the full depth has been reached a reinforcing cage is inserted and concrete is placed by tremie pipe, thus displacing the bentonite mud to the surface.

The grab is normally suspended from a crawler crane, although a tracked excavator base is sometimes used. Diaphragm walling sites frequently need much ancillary equipment including bentonite preparation and reclamation plant, reinforcing cage manufacturing plant, pumps and handling cranes. The layout of plant on the site is important for efficient operation and can exert considerable influence on noise control.

An alternative to the grab is a reverse circulation mill which allows almost continuous removal of spoil within the bentonite mud suspension returns.

Annex I (informative) Air overpressure**I.1 Description**

Whenever blasting is carried out, energy is transmitted from the blast site in the form of airborne pressure waves. These pressure waves comprise energy over a wide range of frequencies, some of which are higher than 20 Hz and therefore perceptible as sound, whereas the majority are below 20 Hz and hence inaudible, but can be sensed as concussion. It is the combination of the sound and concussion that is known as air overpressure.

The attenuation effects due to the topography, either natural or manufactured, between the blast and the receiver are much greater on the audible component of the pressure wave, whereas the effects are relatively slight on the lower frequency concussive component. The energy transmitted in the audible part of the pressure wave is much smaller than that in the concussive part and therefore baffle mounds or other acoustic screening techniques do not significantly reduce the overall air overpressure intensity.

Air overpressure can excite secondary vibrations at an audible frequency in buildings and it is usually this effect which has been found to give rise to comment from occupants. There is no known evidence of structural damage to structures from excessive air overpressure levels from quarry blasting.

Meteorological conditions, over which an operator has no control, such as temperature, cloud cover, humidity, wind speed, turbulence and direction, all affect the intensity of air overpressure at any location and cannot be reliably predicted. These conditions vary in time and position and therefore the reduction in air overpressure values as the distance from the blast increases might be greater in some directions than others.

I.2 Sources of blast-generated air overpressure

The use of detonating cord, inadequate or poor stemming and gas venting are major sources of air overpressure and can be controlled with good blast design. The use of detonating cord can be avoided by adopting the technique of down-the-hole initiation but, if used, any exposed lengths need to be covered with a reasonable thickness of selected overburden. Sufficient stemming with appropriate material such as sized stone chippings is needed. Gas venting can be minimized by good blast design, accurate drilling and careful placement of the correct amount of explosives. The other major sources of air overpressure from blasting are the reflection of stresses from a free face of an unbroken rock mass and also from the physical movement of a rock mass around the shot holes and at other free faces.

Detailed requirements for the use of explosives at quarries are contained in the Quarries (Explosives) Regulations 1988 [63] and the Quarries (Explosives) Regulations (Northern Ireland) 2006 [64].

1.3 Criteria

As the airborne pressure waves pass any single point the pressure of the air rises rapidly to a value above atmospheric pressure, falls to below atmospheric pressure, then returns to normal pressure after a series of oscillations. The maximum value above atmospheric pressure is known as peak air overpressure and is measured in pressure terms and generally expressed in linear decibels (dB lin) (see 1.4).

Routine blasting can regularly generate air overpressure levels at adjacent premises of around 120 dB (lin). This level corresponds to an excess air pressure which is equivalent to that of a steady wind velocity of $5 \text{ m}\cdot\text{s}^{-1}$ (Beaufort force 3, gentle breeze) and is likely to be above the threshold of perception.

Windows are generally the weakest parts of a structure and research by the United States Bureau of Mines [65] has shown that a poorly mounted window that is prestressed might crack at 150 dB (lin), with most windows cracking at around 170 dB (lin), whereas structural damage would not be expected at levels below 180 dB (lin).

1.4 Measurement

Measurement of air overpressure needs to be undertaken with microphones with an adequate low frequency response to fully capture the dominant low frequency component. A 2 Hz high pass system has been found to be satisfactory. Most of the equipment more commonly used for noise measurement is therefore not suitable for measuring overpressure. Although monitoring of air overpressure can be undertaken, due to the uncertainties with meteorological conditions, it is not possible to predict the location of the maximum air overpressure.

Additionally, pressure variations in the atmosphere due to windy conditions can mask the blast generated air overpressure levels. For these reasons it is not accepted practice to set specific limits for air overpressure. In order to control air overpressure the best practical approach is to take measures to minimize its generation at source.

Bibliography

Standards publications

For dated references, only the edition cited applies. For undated references, the latest edition of the referenced document (including any amendments) applies.

BS 5228-1:1997 (withdrawn), *Noise and vibration control on construction and open sites – Part 1: Code of practice for basic information and procedures for noise and vibration control*

BS 5228-2:2009, *Code of practice for noise and vibration control on construction and open sites – Part 2: Vibration*

BS 5228-4:1992 (withdrawn), *Noise control on construction and open sites – Part 4: Code of practice for noise and vibration control applicable to piling operations*

BS 6164, *Code of practice for safety in tunnelling in the construction industry*

BS 7189:1989 (IEC 942:1988) (now withdrawn), *Specification for sound calibrators*

BS 7445-1, *Description and measurement of environmental noise – Part 1: Guide to quantities and procedures*

BS 7445-2, *Description and measurement of environmental noise – Part 2: Guide to the acquisition of data pertinent to land use*

BS 7445-3, *Description and measurement of environmental noise – Part 3: Guide to application to noise limits*

BS EN 60804:1994 (now withdrawn), *Specification for integrating averaging sound level meters*

BS EN 60804:2001 (now withdrawn), *Integrating averaging sound level meters*

BS EN 60942:1998 (now withdrawn), *Electroacoustics – Sound calibrators*

BS EN ISO/IEC 17025, *General requirements for the competence of testing and calibration laboratories*

BS ISO 8528-1:2005, *Reciprocating internal combustion engine driven alternating current generating sets – Part 1: Application, ratings and performance*

Other publications

- [1] JOHNSON, D.B., WILTON, T.J., et al. *The environmental effects of production blasting from surface mineral workings*. London: The Stationery Office, 1998. ISBN 0117 534129.
- [2] GREAT BRITAIN. *Control of Noise at Work Regulations 2005*. London: The Stationery Office.
- [3] HEALTH AND SAFETY EXECUTIVE. *Controlling noise at work – The Control of Noise at Work Regulations 2005 – Guidance on Regulations*. L108. Sudbury: HSE Books, 2005. ISBN 0717661644.
- [4] GREAT BRITAIN. *Construction (Design and Management) Regulations 2007*. London: The Stationery Office.

- [5] GREAT BRITAIN. Construction (Design and Management) Regulations 1994. London: HMSO.
- [6] GREAT BRITAIN. Construction (Health, Safety and Welfare) Regulations 1996. London: HMSO.
- [7] HEALTH AND SAFETY EXECUTIVE. *Managing health and safety in construction – Construction (Design and Management) Regulations 2007 – Approved Code of Practice*. L144. Sudbury: HSE Books, 2007.
- [8] CONSTRUCTION INDUSTRY RESEARCH AND INFORMATION ASSOCIATION (CIRIA). *A guide to reducing the exposure of construction workers to noise*. Report 120. London: CIRIA, 1990¹⁾
- [9] GREAT BRITAIN. Control of Pollution Act 1974. London: HMSO.
- [10] GREAT BRITAIN. Environmental Protection Act 1990. London: HMSO.
- [11] EUROPEAN COMMUNITIES. 2000/14/EC. Directive 2000/14/EC of the European Parliament and of the Council of 8 May 2000 on the approximation of the laws of the Member States relating to the noise emission in the environment by equipment for use outdoors. Luxembourg: Office for Official Publications of the European Communities, 2000.
- [12] GREAT BRITAIN. Health and Safety at Work etc. Act 1974. London: HMSO.
- [13] GREAT BRITAIN. Workplace (Health, Safety and Welfare) Regulations 1992. London: HMSO.
- [14] GREAT BRITAIN. Management of Health and Safety at Work Regulations 1992. London: HMSO.
- [15] ^{A1} DEPARTMENT FOR COMMUNITIES AND LOCAL GOVERNMENT. *Technical Guidance to the National Planning Policy Framework*. London: DCLG, 2012.²⁾ ^{A1}
- [16] SCOTTISH OFFICE DEVELOPMENT DEPARTMENT. *Planning Advice Note 50 – Controlling the environmental effects of surface mineral workings – Annex A: The control of noise at surface mineral workings*. PAN 50 Annex A. Crown Copyright, 1996.
- [17] GREAT BRITAIN. Pollution Control and Local Government (Northern Ireland) Order 1978. Belfast: HMSO.
- [18] EUROPEAN COMMUNITIES. 2005/88/EC. Directive 2005/88/EC of the European Parliament and of the Council of 14 December 2005 amending Directive 2000/14/EC on the approximation of the laws of the Member States relating to the noise emission in the environment by equipment for use outdoors (Text with EEA relevance). Luxembourg: Office for Official Publications of the European Communities, 2005.
- [19] GREAT BRITAIN. Health and Safety at Work (Northern Ireland) Order 1978. Belfast: HMSO.

¹⁾ Available from CIRIA, Classic House, 174–180 Old Street, London, EC1V 9BP.

^{A1} ²⁾ Available from Department for Communities and Local Government, Eland House, Bressenden Place, London SW1E 5DU. ^{A1}

- [20] EUROPEAN COMMUNITIES. 2003/10/EC. Directive 2003/10/EC of the European Parliament and of the Council of 6 February 2003 on the minimum health and safety requirements regarding the exposure of workers to the risks arising from physical agents (noise). Luxembourg: Office for Official Publications of the European Communities, 2003.
- [21] GREAT BRITAIN. Control of Noise at Work Regulations (Northern Ireland) 2006. Belfast: The Stationery Office.
- [22] GREAT BRITAIN. Control of Noise (Appeals) Regulations 1975. London: HMSO.
- [23] GREAT BRITAIN. Statutory Nuisance (Appeals) Regulations 1990. London: HMSO.
- [24] GREAT BRITAIN. Control of Noise (Appeals) Regulations (Northern Ireland) 1978. Belfast: HMSO.
- [25] GREAT BRITAIN. Control of Noise (Appeals) (Scotland) Regulations 1983. London: HMSO.
- [26] GREAT BRITAIN. Building Regulations 2000 and subsequent amendments. London: The Stationery Office.
- [27] GREAT BRITAIN. Building Standards (Scotland) Regulations 1990 and subsequent amendments. London: HMSO.
- [28] GREAT BRITAIN. Building Regulations (Northern Ireland) 2000. London: The Stationery Office.
- [29] GREAT BRITAIN. Building (Scotland) Act 2003. London: The Stationery Office.
- [30] GREAT BRITAIN. Noise Insulation Regulations 1975. London: HMSO.
- [31] GREAT BRITAIN. Noise Insulation (Scotland) Regulations 1975. London: HMSO.
- [32] GREAT BRITAIN. Noise Insulation (Northern Ireland) Regulations 1995. Belfast: HMSO.
- [33] GREAT BRITAIN. Land Compensation Act 1973. London: HMSO.
- [34] GREAT BRITAIN. Land Compensation (Scotland) Act 1973. London: HMSO.
- [35] GREAT BRITAIN. Land Acquisition and Compensation (Northern Ireland) Order 1973. Belfast: HMSO.
- [36] GREAT BRITAIN. Highways Act 1980. London: HMSO.
- [37] GREAT BRITAIN. Noise Insulation (Railways and Other Guided Transport Systems) Regulations 1995. London: HMSO.
- [38]  Reference deleted 
- [39]  Reference deleted 
- [40] OFFICE OF THE DEPUTY PRIME MINISTER. *Minerals Planning Guidance 9 – Planning and Compensation Act 1991 – Interim development order permissions (IDOS): conditions*. MPG 9. Norwich: The Stationery Office, 1992.
- [41] GREAT BRITAIN. Coal Industry Act 1994. London: HMSO.
- [42] GREAT BRITAIN. Coal Industry Nationalisation Act 1946. London: HMSO.
- [43] GREAT BRITAIN. Opencast Coal Act 1958. London: HMSO.

- [44] GREAT BRITAIN. Town and Country Planning Act 1990. London: HMSO.
- [45] GREAT BRITAIN. Planning and Compulsory Purchase Act 2004. London: HMSO.
- [46] GREAT BRITAIN. Town and Country Planning (General Development Procedure) Order 1995. London: HMSO.
- [47] GREAT BRITAIN. Town and Country Planning (Environmental Impact Assessment) (England and Wales) Regulations 1999. London: The Stationery Office.
- [48] GREAT BRITAIN. Town and Country Planning (Scotland) Act 1972. London: HMSO.
- [49] GREAT BRITAIN. Planning and Compensation Act 1991. London: HMSO.
- [50] GREAT BRITAIN. Planning (Northern Ireland) Order 1991. London: HMSO.
- [51] GREAT BRITAIN. Environment Act 1995. London: HMSO.
- [52] ~~A1~~ Reference deleted ~~A1~~
- [53] SCOTTISH OFFICE DEVELOPMENT DEPARTMENT. *National Planning Policy Guideline 4 – Land for mineral working*. NPPG 4. Crown Copyright, 1994.
- [54] SCOTTISH OFFICE DEVELOPMENT DEPARTMENT. *Planning Advice Note 50 – Controlling the environmental effects of surface mineral workings*. PAN 50. Crown Copyright, 1996.
- [55] OFFICE OF THE DEPUTY PRIME MINISTER. *Minerals Planning Guidance 2 – Applications, permissions and conditions*. MPG 2. Norwich: The Stationery Office, 1998.
- [56] OFFICE OF THE DEPUTY PRIME MINISTER. *Minerals Planning Guidance 8 – Planning and Compensation Act 1991 – Interim development order permissions (IDOS): statutory procedures and procedures*. MPG 8. Norwich: The Stationery Office, 1991.
- [57] CONSTRUCTION INDUSTRY RESEARCH AND INFORMATION ASSOCIATION (CIRIA). *Noise from construction and demolition sites – Measured levels and their prediction*. Report 64. London: CIRIA, 1977.³⁾
- [58] GREAT BRITAIN. Noise Emission in the Environment by Equipment for Use Outdoors Regulations 2001, as amended. London: The Stationery Office.
- [59] GREAT BRITAIN. Noise Emission in the Environment by Equipment for Use Outdoors (Amendment) Regulations 2005. London: The Stationery Office.
- [60] GREAT BRITAIN. *Committee on the problem of noise – Final report*. Command paper 2056. London, HMSO, July 1963. ISBN 0 10 850091 8.
- [61] DEPARTMENT OF THE ENVIRONMENT. *Noise control on building sites*. Advisory Leaflet 72, 3rd Edition. London: HMSO, 1976. ISBN 0 11 670664 3.⁴⁾

³⁾ Available from CIRIA, Classic House, 174–180 Old Street, London, EC1V 9BP.

⁴⁾ No longer in print, but available from the British Library.

- [62] WADDINGTON, D. and MOORHOUSE, A. *Construction noise database (phase 3) – Evaluation of established measurement protocol – Report for DEFRA*. Manchester: Salford University, April 2006.
- [63] GREAT BRITAIN. Quarries (Explosives) Regulations 1988. London: HMSO.
- [64] GREAT BRITAIN. Quarries (Explosives) Regulations (Northern Ireland) 2006. London: The Stationery Office.
- [65] SISKIND, D.E., STACHURA, V.J., STAGG, M.S., and KOPP, J. W., *Structure response and damage produced by airblast from surface mining*. RI 8485. Washington D.C.: US Bureau of Mines Report of Investigations, 1980.

Further reading

NOTE These publications were listed in the previous edition of BS 5228. They are no longer specifically referred to in the standard but have been retained as they provide additional guidance.

DEPARTMENT OF THE ENVIRONMENT. *Planning Policy Guidance Note 24 – Planning and noise*. PPG 24. London: The Stationery Office, 1994.

DOWDING, C.H. *Blast vibration monitoring and control*. Englewood Cliffs, New Jersey, USA: Prentice-Hall, Inc., 1985.

GILL, H.S. Control of impact pile driving noise and study of alternative techniques. *Noise Control Engineering Journal*. March–April 1983. pp. 76–83.

HEALTH AND SAFETY EXECUTIVE. *Control of Noise in Quarries*. HSG 109. Sudbury: HSE Books, 1993. ISBN 07176 0648 1.

INSTITUTION OF CIVIL ENGINEERS. *Specification for piling and embedded retaining walls*. Second edition. London: Thomas Telford Ltd, 2007. ISBN 9780727733580.

WALLER, R.A. (Roy Waller Associates). *Environmental effects of surface mineral workings*. Department of the Environment Research Report, London: The Stationery Office, 1994.

W.S. ATKINS ENGINEERING SERVICES (for The Department of the Environment). *The control of noise at surface mineral workings*, London, The Stationery Office, 1990. ISBN 0 11 752 338 0.

WYNNE, C.P. *A review of bearing pile types*. CIRIA Report PG. 1, January 1977: reprinted 1988.⁵⁾

⁵⁾ Available from CIRIA, Classic House, 174–180 Old Street, London, EC1V 9BP.

British Standards Institution (BSI)

BSI is the national body responsible for preparing British Standards and other standards-related publications, information and services.

BSI is incorporated by Royal Charter. British Standards and other standardization products are published by BSI Standards Limited.

About us

We bring together business, industry, government, consumers, innovators and others to shape their combined experience and expertise into standards-based solutions.

The knowledge embodied in our standards has been carefully assembled in a dependable format and refined through our open consultation process. Organizations of all sizes and across all sectors choose standards to help them achieve their goals.

Information on standards

We can provide you with the knowledge that your organization needs to succeed. Find out more about British Standards by visiting our website at bsigroup.com/standards or contacting our Customer Services team or Knowledge Centre.

Buying standards

You can buy and download PDF versions of BSI publications, including British and adopted European and international standards, through our website at bsigroup.com/shop, where hard copies can also be purchased.

If you need international and foreign standards from other Standards Development Organizations, hard copies can be ordered from our Customer Services team.

Subscriptions

Our range of subscription services are designed to make using standards easier for you. For further information on our subscription products go to bsigroup.com/subscriptions.

With **British Standards Online (BSOL)** you'll have instant access to over 55,000 British and adopted European and international standards from your desktop. It's available 24/7 and is refreshed daily so you'll always be up to date.

You can keep in touch with standards developments and receive substantial discounts on the purchase price of standards, both in single copy and subscription format, by becoming a **BSI Subscribing Member**.

PLUS is an updating service exclusive to BSI Subscribing Members. You will automatically receive the latest hard copy of your standards when they're revised or replaced.

To find out more about becoming a BSI Subscribing Member and the benefits of membership, please visit bsigroup.com/shop.

With a **Multi-User Network Licence (MUNL)** you are able to host standards publications on your intranet. Licences can cover as few or as many users as you wish. With updates supplied as soon as they're available, you can be sure your documentation is current. For further information, email bsmusales@bsigroup.com.

BSI Group Headquarters

389 Chiswick High Road London W4 4AL UK

Revisions

Our British Standards and other publications are updated by amendment or revision.

We continually improve the quality of our products and services to benefit your business. If you find an inaccuracy or ambiguity within a British Standard or other BSI publication please inform the Knowledge Centre.

Copyright

All the data, software and documentation set out in all British Standards and other BSI publications are the property of and copyrighted by BSI, or some person or entity that owns copyright in the information used (such as the international standardization bodies) and has formally licensed such information to BSI for commercial publication and use. Except as permitted under the Copyright, Designs and Patents Act 1988 no extract may be reproduced, stored in a retrieval system or transmitted in any form or by any means – electronic, photocopying, recording or otherwise – without prior written permission from BSI. Details and advice can be obtained from the Copyright & Licensing Department.

Useful Contacts:

Customer Services

Tel: +44 845 086 9001

Email (orders): orders@bsigroup.com

Email (enquiries): cservices@bsigroup.com

Subscriptions

Tel: +44 845 086 9001

Email: subscriptions@bsigroup.com

Knowledge Centre

Tel: +44 20 8996 7004

Email: knowledgecentre@bsigroup.com

Copyright & Licensing

Tel: +44 20 8996 7070

Email: copyright@bsigroup.com

bsi.

...making excellence a habit.™